



測定日	2025年2月14日
測定場所	公益財団法人 福岡県産業・科学技術振興財団 社会システム実証センター（福岡県糸島市）
評価状況	<p>評価内容 RTA825（以下被評価アンテナ）の放射パターンおよび最大放射方向の利得をマルチアキスポジショニングシステムにより測定。（地板として 20cm 四方のアルミ板を使用）被評価アンテナケーブル長 0.45m・SMAP コネクター付き</p> <p>注：RTA825 と MG825 は取付け方法が異なるのみで、電気的特性は同一ケーブル損失データを元に各ケーブル長におけるアンテナ利得を算出</p>
測定周波数 (MHz)	<p>715、731.5、748、770、786.5</p> <p>803、815、830、845、860、875、890</p> <p>900、907.5、915、945、952.5、960</p> <p>1427.9、1445.4、1462.9、1475.9、1493.4</p> <p>1510.9、1575.42</p> <p>1710、1747.45、1784.9</p> <p>1805、1842.45、1879.9</p> <p>1920、1950、1980</p> <p>2110、2140、2170</p> <p>2330、2350、2370</p> <p>2401、2449、2497</p> <p>2545、2595、2645</p> <p>3400、3500、3600、3850</p> <p>4100、4500、4550、4600、4750、4900</p> <p>5170、5250、5330、5490、5610、5730、5945</p>

1. 一般事項	
1-1 適用範囲	この規格は、マグネットアンテナ (MG825- * -SMAP) の機械的性能および、電気的性能について適用する。
2. 外観・寸法	
2-1 外観	外観は裸眼で約 30cm 離し、機能上有害な錆、割れ、傷等がない事とする。
2-2 寸法	寸法 8.0x4.7x9.3cm (ケーブル含まず)
3. 機械的性能	
3-1 塩水噴霧試験	JIS Z2371 の中性塩水噴霧試験 72 時間に準拠 電気的特性と機械的特性に異常を認めない
3-2 ケーブル引張強度	1.5D-QFB(又は相当品) に 98N の静荷重を加えてケーブルが破断しないこと。但し、コネクタとアンテナの接続部を除く。
3-3 使用・保存温度範囲	-30℃～ 85℃の温度範囲内にて外観に変形・割れがなく、電気的特性を満足すること。
4. 電気的性能	
4-1 試験状況	
4-2 V.S.W.R.	28(n28) ( 715 ~ 748 ) " ( 770 ~ 803 ) 18(n18) ( 815 ~ 830 ) " ( 860 ~ 875 ) 19(n5) ( 830 ~ 845 ) " ( 875 ~ 890 ) 8(n8) ( 900 ~ 915 ) " ( 945 ~ 960 ) 11(n74) ( 1427.9 ~ 1447.9 ) 21(n74) ( 1447.9 ~ 1462.9 ) 11(n74) ( 1475.9 ~ 1495.9 ) 21(n74) ( 1495.9 ~ 1510.9 ) GPS ( 1575.42 ) 3(n3) ( 1710 ~ 1725 ) " ( 1730 ~ 1784.9 ) " ( 1805 ~ 1865 ) " ( 1859.9 ~ 1879.9 ) 1(n1) ( 1920 ~ 1980 ) " ( 2110 ~ 2170 ) n40 ( 2330 ~ 2370 ) Wifi ( 2401 ~ 2497 ) n41 ( 2545 ~ 2645 ) 42(n78) ( 3400 ~ 3600 ) n77,n78( 3600 ~ 4000 ) " ( 4000 ~ 4100 ) n79 ( 4500 ~ 4900 ) Wifi ( 5170 ~ 5330 ) " ( 5490 ~ 5730 ) " ( 5945 ~ 6425 ) .5GHz 帯 (Band11,21) 3.0 : 1 以下 その他の使用周波数帯 2.0 : 1 以下 (1.5DX-FB ケーブル 2.5m のとき)
14-3 入力インピーダンス	50 Ω
4-4 利得	使用周波数範囲において 3dBi 以下 ケーブル長制限：利得を 3dBi 以下とするために、1.5DXB 2.5m 相当以上のロス (900MHz で 1.5dB) を有するケーブルを使用する

アンテナ仕様

仕様項目		仕様内容	
1	型名	MG825-*SMAP MG825-(ケーブル長)-(コネクタの型式)を示す。 5mの場合、MG825-5-SMAP	
2	品名	ルーフトップアンテナ	
3	使用周波数 (MHz)	28(n28) ( 715 ~ 748 )	
		" ( 770 ~ 803 )	
		18(n18) ( 815 ~ 830 )	
		" ( 860 ~ 875 )	
		19(n5) ( 830 ~ 845 )	
		" ( 875 ~ 890 )	
		8(n8) ( 900 ~ 915 )	
		" ( 945 ~ 960 )	
		11(n74) ( 1427.9 ~ 1447.9 )	
		21(n74) ( 1447.9 ~ 1462.9 )	
		11(n74) ( 1475.9 ~ 1495.9 )	
		21(n74) ( 1495.9 ~ 1510.9 )	
		GPS ( 1575.42 )	
		3(n3) ( 1710 ~ 1725 )	
		" ( 1730 ~ 1784.9 )	
		" ( 1805 ~ 1865 )	
		" ( 1859.9 ~ 1879.9 )	
		1(n1) ( 1920 ~ 1980 )	
		" ( 2110 ~ 2170 )	
		n40 ( 2330 ~ 2370 )	
		Wifi ( 2401 ~ 2497 )	
		n41 ( 2545 ~ 2645 )	
		42(n78) ( 3400 ~ 3600 )	
		n77,n78( 3600 ~ 4000 )	
		" ( 4000 ~ 4100 )	
		n79 ( 4500 ~ 4900 )	
		Wifi ( 5170 ~ 5330 )	
		" ( 5490 ~ 5730 )	
		" ( 5945 ~ 6425 )	
4	形式	単一型 (V) 1/4 λ	
5	入力インピーダンス	50 Ω	
6	定在波比	1.5GHz帯 (Band11,21) 3.0 : 1 以下 その他の使用周波数帯 2.0 : 1 以下 (1.5DXB ケーブル 2.5m のとき)	
7	放射パターン特性	水平面内指向性 無指向性	
8	絶縁抵抗	給電端子乾燥時 DC500V にて 500M Ω 以上	
9	耐電圧	給電端子乾燥時 AC1000V、1 分間加えて異常なき事	
10	接続端子	SMA-P 型	
11	アンテナ部寸法	外観図参照	
12	質量 (ケーブル含まず)	約 90g	
13	取付け方法	マグネット吸着	

外観図

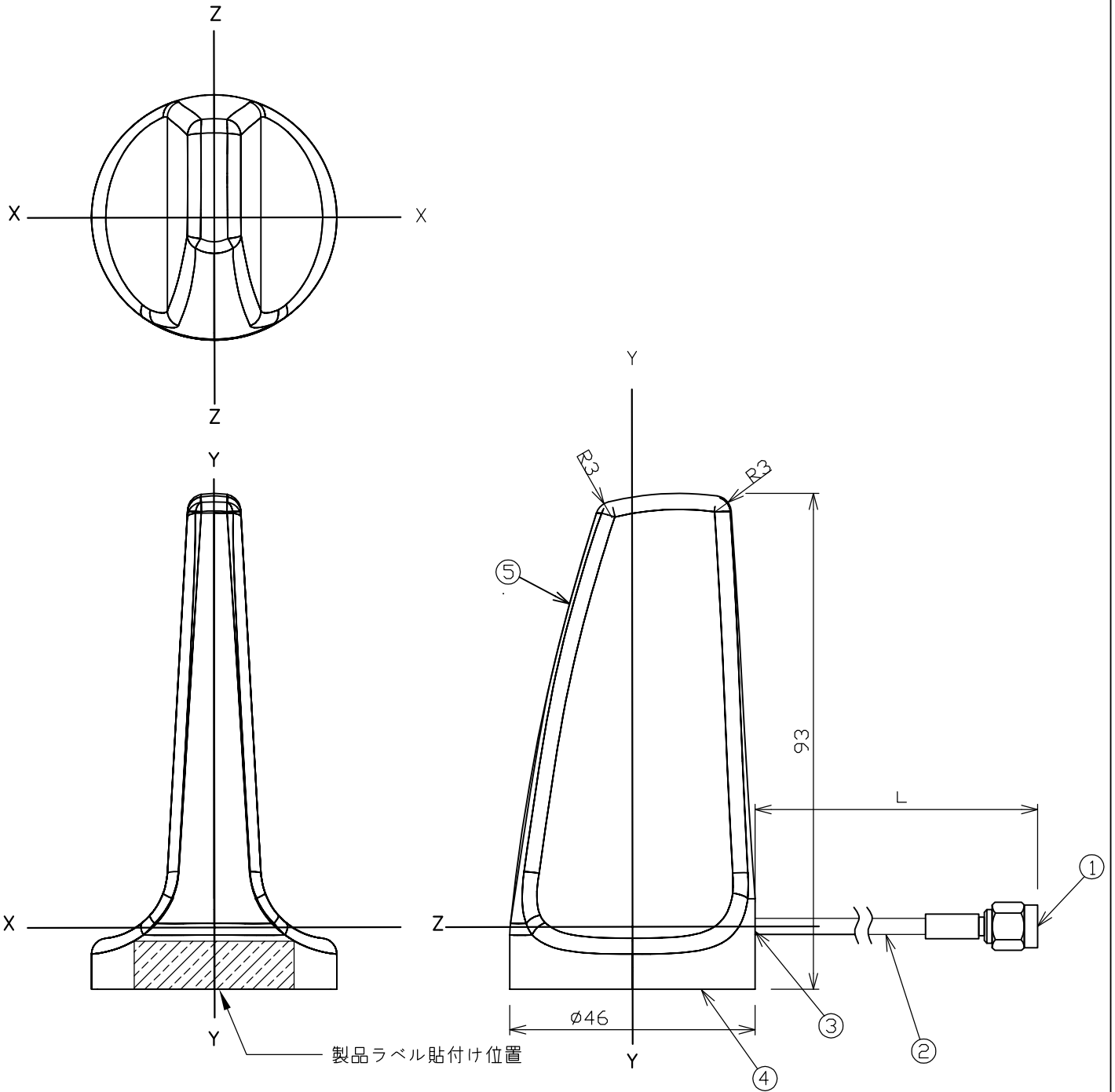

L  
\*\*\*mm±3%

5	アンテナレドーム	ABS	黒
4	キャップマグネット	Fe	三価クロメート
3	グロメット	NPE	黒
2	1.5DX-FB (又は相当品)	PVC	黒
1	SMA-P型	Bs	メッキ仕上げ
部番	部品名	材質	備考

尺度	単位 mm	SAGA DENSHI KOGYO CO.,LTD.	
図番 2022012601		図名 MG825-＊-SMAP 外観図	
新宅	小柳	FILE NAME MG825外観図.dwg	

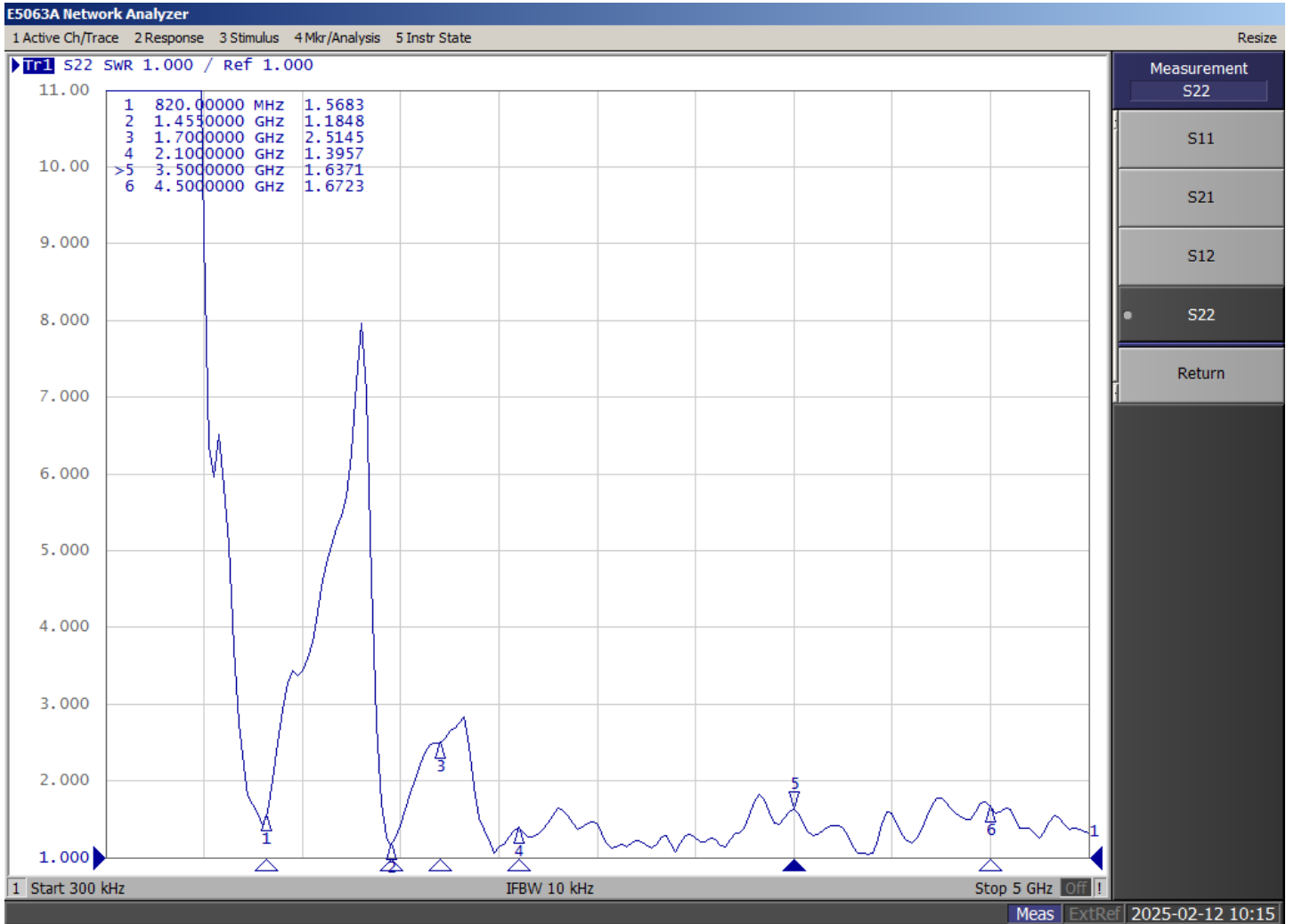

周波数 (MHz)	RTA825(MG825)- * -SMAP 利得(dBi) * :ケーブル長(m)					
	1m	2m	2.5m	3m	5m	10m
715	0.86	0.31	0.03	-0.24	-1.34	-4.09
731.5	1.29	0.74	0.47	0.20	-0.89	-3.60
748	1.51	0.96	0.69	0.41	-0.68	-3.43
770	1.92	1.36	1.08	0.80	-0.32	-3.11
786.5	2.54	1.97	1.69	1.40	0.27	-2.57
803	1.95	1.38	1.09	0.80	-0.36	-3.24
815	1.94	1.36	1.06	0.77	-0.39	-3.31
830	1.76	1.17	0.88	0.58	-0.60	-3.54
845	1.40	0.81	0.52	0.23	-0.95	-3.89
860	1.11	0.52	0.23	-0.07	-1.24	-4.18
875	0.80	0.21	-0.09	-0.39	-1.58	-4.55
890	0.77	0.17	-0.14	-0.44	-1.65	-4.69
900	0.51	-0.10	-0.41	-0.71	-1.94	-4.99
907.5	0.23	-0.38	-0.69	-1.00	-2.22	-5.29
915	0.17	-0.45	-0.76	-1.07	-2.31	-5.40
945	0.19	-0.44	-0.76	-1.08	-2.34	-5.51
952.5	0.21	-0.43	-0.75	-1.06	-2.34	-5.53
960	0.52	-0.11	-0.43	-0.74	-2.00	-5.15
1427.9	3.75	2.94	2.54	2.14	0.52	-3.50
1445.4	3.54	2.74	2.33	1.93	0.31	-3.73
1462.9	3.67	2.88	2.48	2.08	0.50	-3.47
1475.9	3.48	2.68	2.28	1.88	0.28	-3.73
1493.4	3.64	2.82	2.42	2.01	0.37	-3.71
1510.9	3.35	2.52	2.11	1.69	0.04	-4.11
1575.42	2.70	1.85	1.43	1.01	-0.67	-4.89
1710	1.16	0.27	-0.17	-0.61	-2.38	-6.81
1747.45	1.28	0.39	-0.06	-0.51	-2.30	-6.78
1784.9	0.38	-0.52	-0.97	-1.43	-3.24	-7.77
1805	0.22	-0.70	-1.16	-1.62	-3.47	-8.07
1842.45	2.44	1.52	1.06	0.60	-1.24	-5.84
1879.9	3.48	2.54	2.07	1.60	-0.28	-4.98
1920	3.65	2.70	2.23	1.76	-0.14	-4.87
1950	3.73	2.76	2.28	1.80	-0.12	-4.93
1980	4.28	3.31	2.82	2.34	0.39	-4.46
2110	4.30	3.30	2.81	2.31	0.31	-4.67
2140	4.23	3.23	2.73	2.23	0.23	-4.77
2170	4.30	3.28	2.77	2.26	0.22	-4.86
2330	3.84	2.77	2.23	1.69	-0.45	-5.82
2350	3.78	2.71	2.17	1.64	-0.50	-5.84
2370	3.95	2.87	2.33	1.79	-0.37	-5.77
2401	3.80	2.73	2.19	1.65	-0.50	-5.88
2449	3.86	2.76	2.20	1.65	-0.56	-6.09
2497	3.78	2.67	2.12	1.56	-0.66	-6.20
2545	4.05	2.92	2.35	1.78	-0.49	-6.16
2595	4.56	3.42	2.86	2.29	0.02	-5.65
2645	5.56	4.42	3.85	3.29	1.02	-4.65
3400	5.39	4.09	3.45	2.80	0.21	-6.27
3500	4.95	3.60	2.92	2.25	-0.45	-7.20
3600	5.58	4.15	3.44	2.73	-0.12	-7.23
3850	8.57	7.14	6.42	5.70	2.84	-4.32
4100	7.68	6.17	5.42	4.67	1.65	-5.88
4500	8.48	6.86	6.06	5.25	2.02	-6.05
4550	7.97	6.38	5.59	4.80	1.64	-6.28
4600	7.77	6.16	5.36	4.56	1.35	-6.67
4750	6.51	4.87	4.04	3.22	-0.07	-8.29

4900	5.49	3.81	2.97	2.13	-1.23	-9.62
5170	3.45	1.70	0.83	-0.05	-3.54	-12.29
5250	2.53	0.73	-0.17	-1.07	-4.67	-13.69
5330	1.37	-0.40	-1.29	-2.18	-5.72	-14.59
5490	1.40	-0.44	-1.36	-2.27	-5.95	-15.13
5610	0.20	-1.68	-2.62	-3.56	-7.32	-16.71
5730	0.59	-1.35	-2.32	-3.29	-7.17	-16.88
5945	-0.39	-2.31	-3.27	-4.23	-8.07	-17.68

RTA825(MG825) 指向性特性

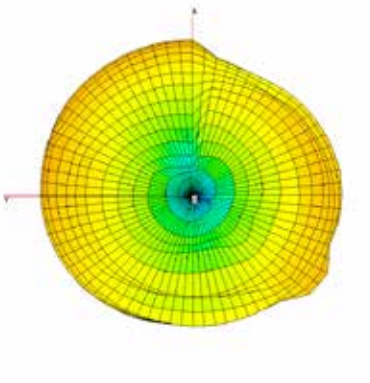
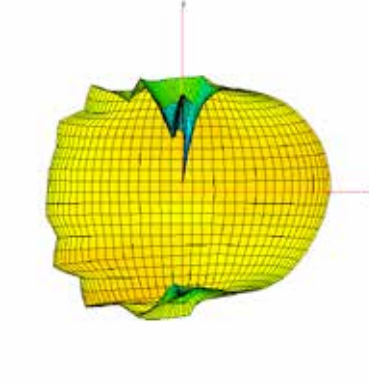
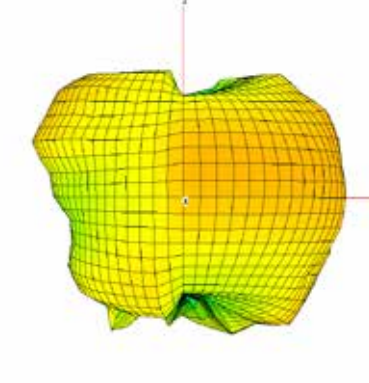
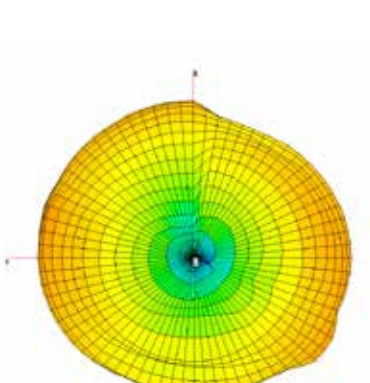
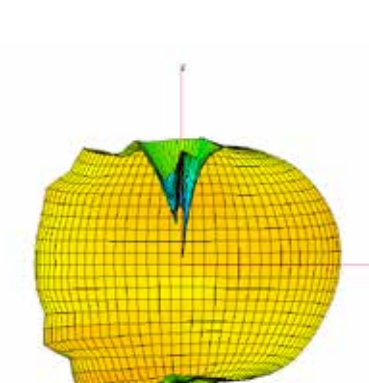
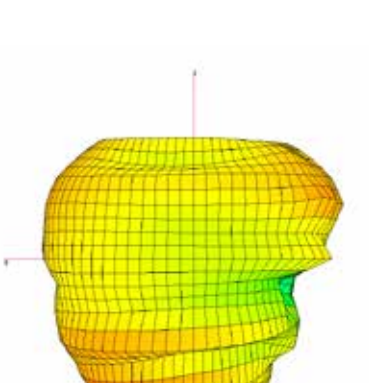
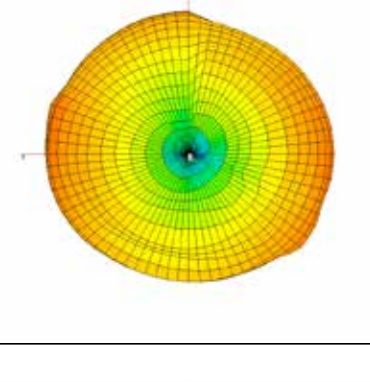
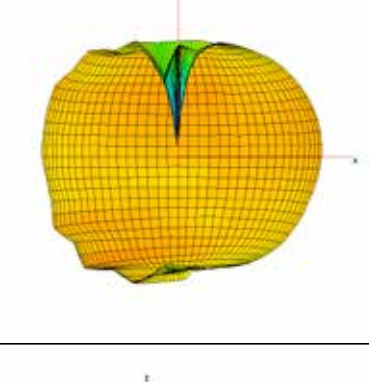
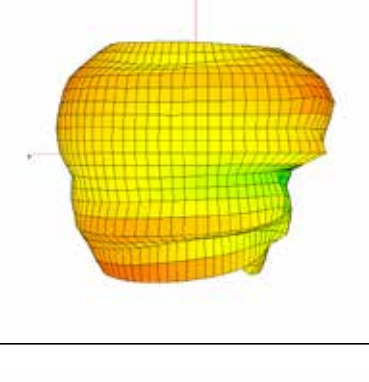
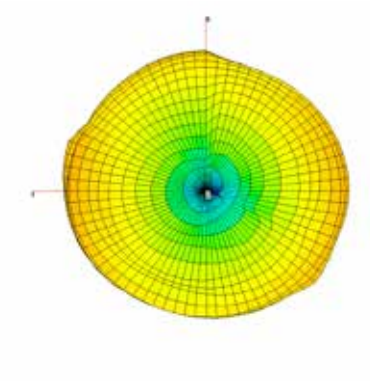
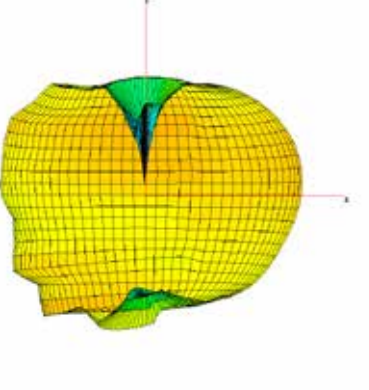
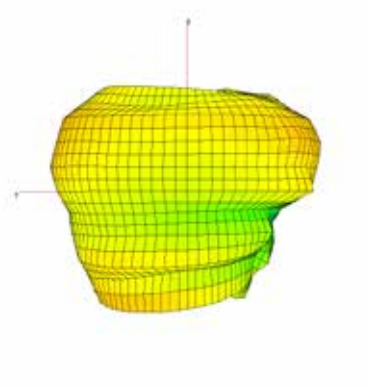
周波数 (MHz)	X-Y	X-Z	Y-Z
715			
731.5			
748			
770			

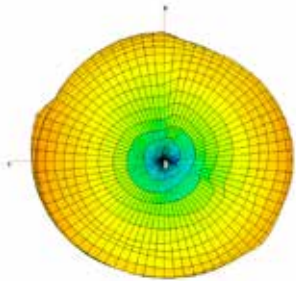
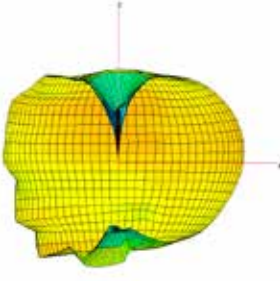
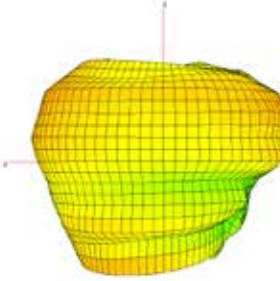
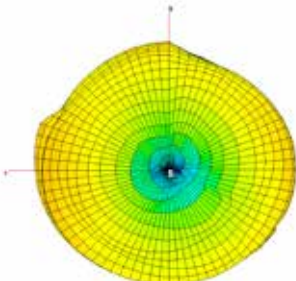
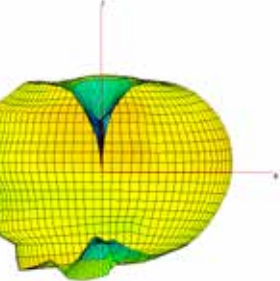
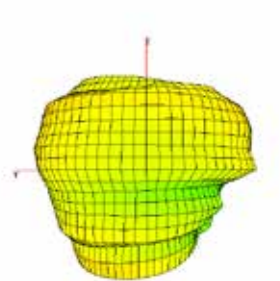
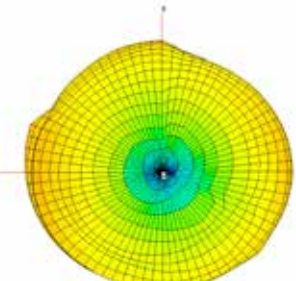
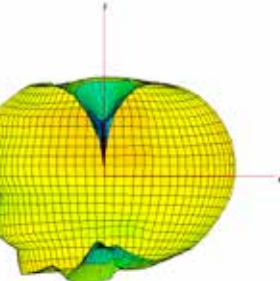
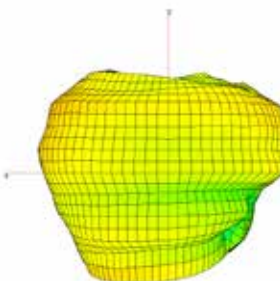
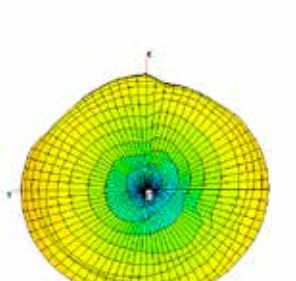
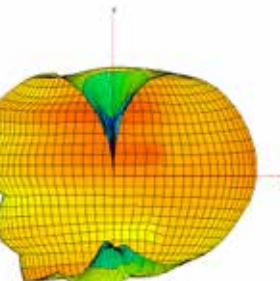
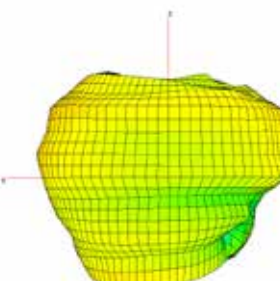
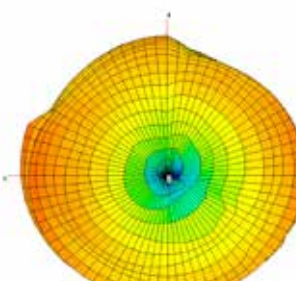
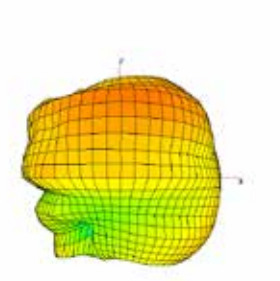
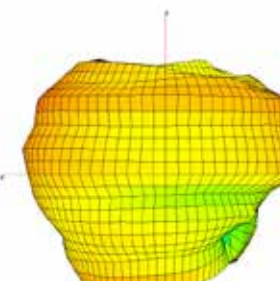

786.5			
803			
815			
830			
845			

860			
875			
890			
900			
907.5			

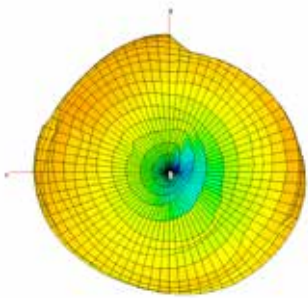
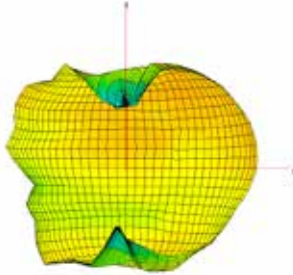
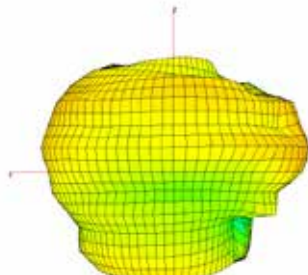
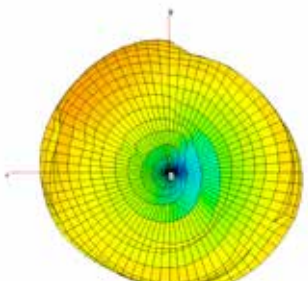
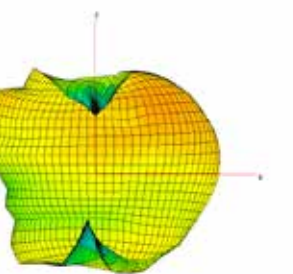
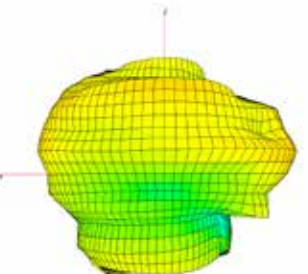
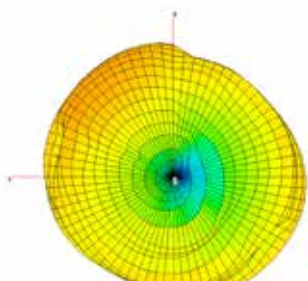
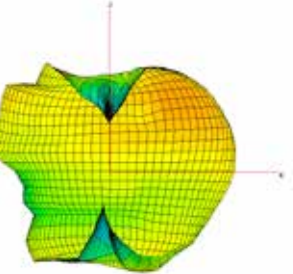
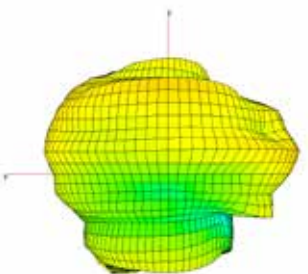
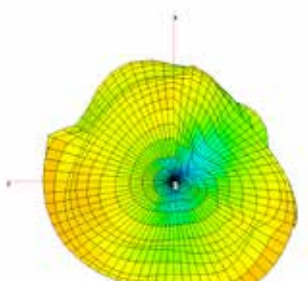
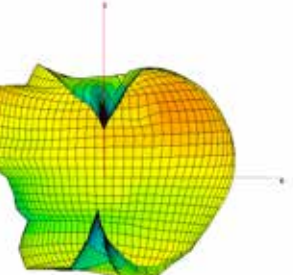
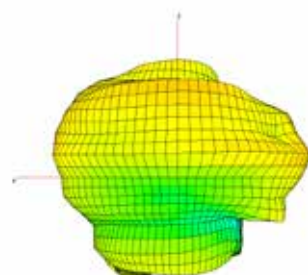
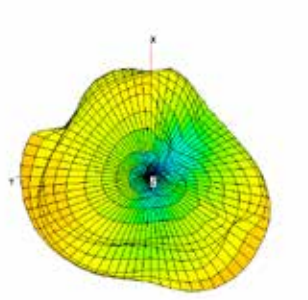
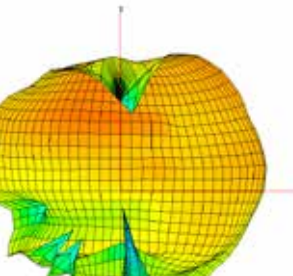
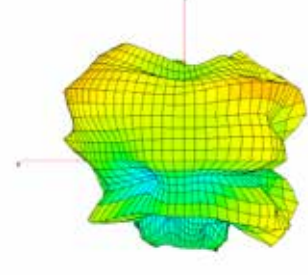

915			
945			
952.5			
960			
1427.9			

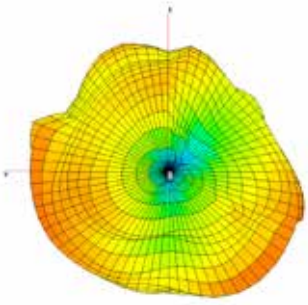
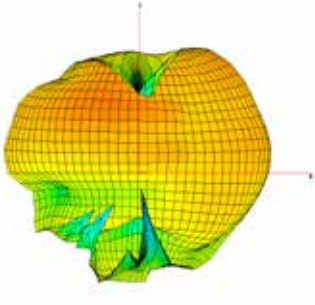
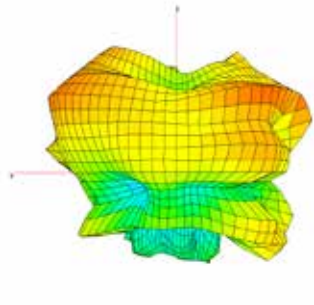
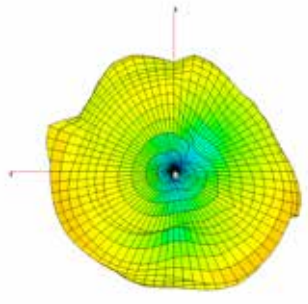
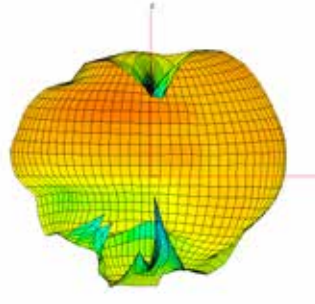
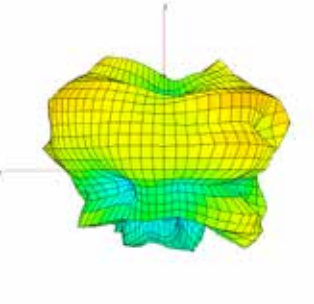
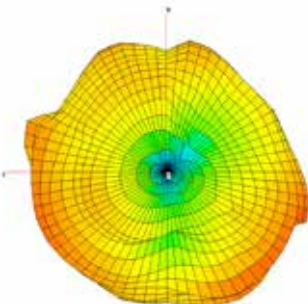
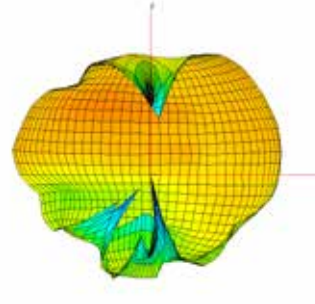
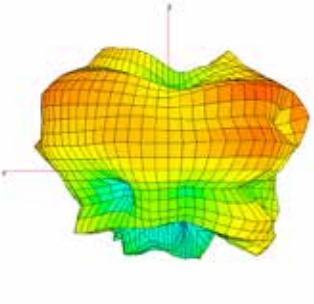
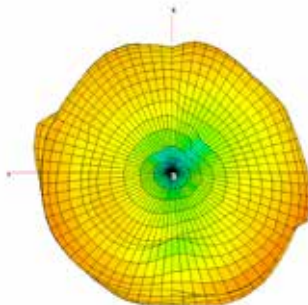
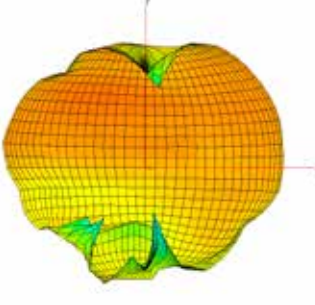
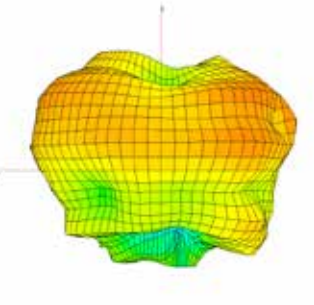
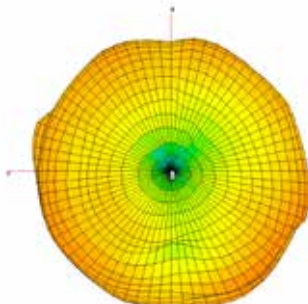
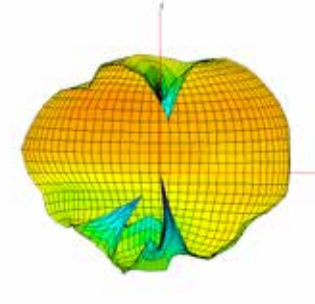
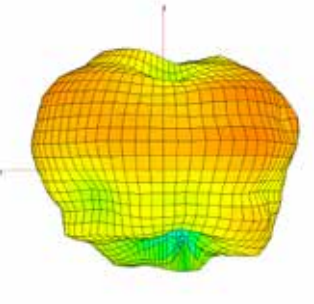
1445.4			
1462.9			
1475.9			
1493.4			
1510.9			

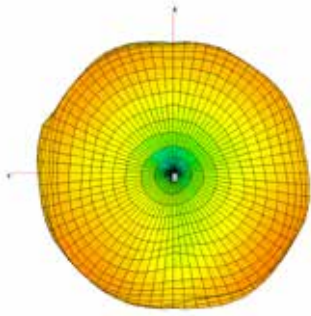
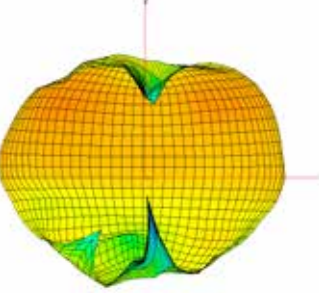
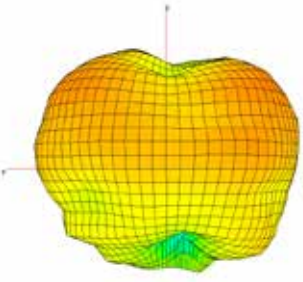
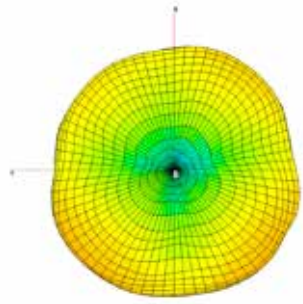
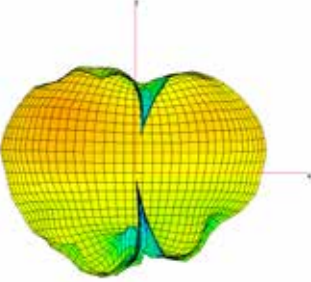
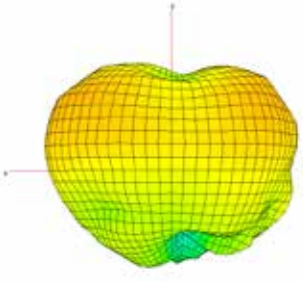
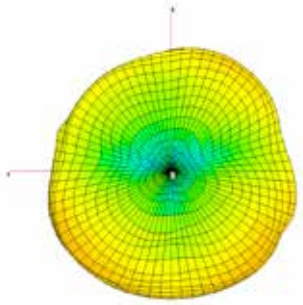
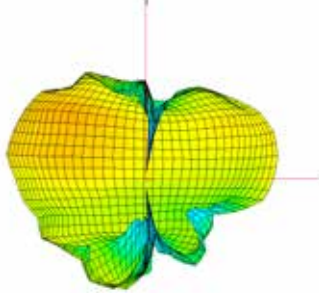
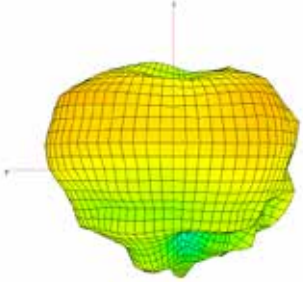
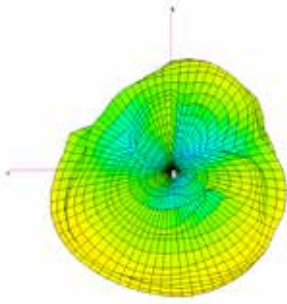
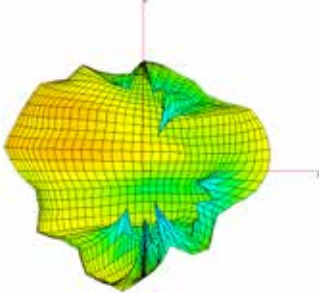
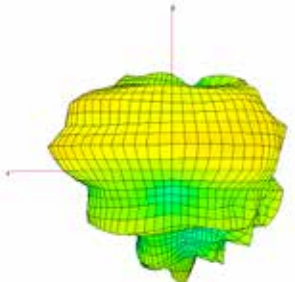
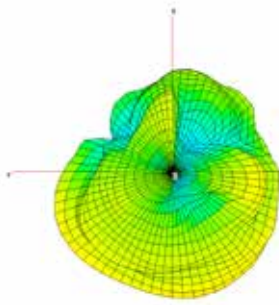
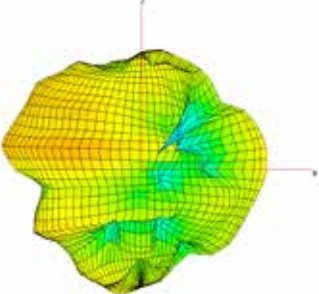
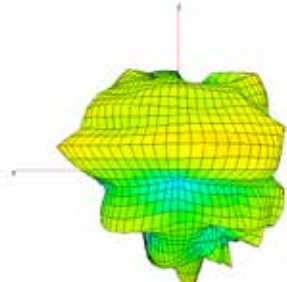

1575.42			
1710			
1747.45			
1784.9			
1805			

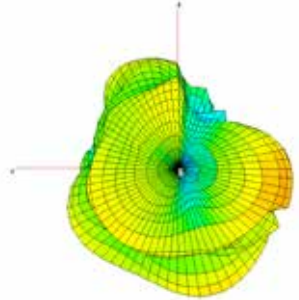
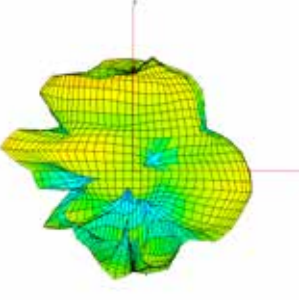
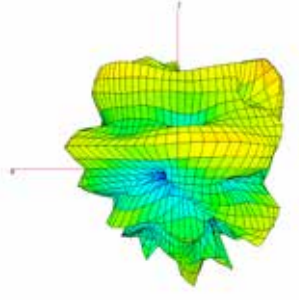
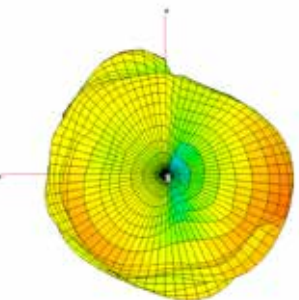
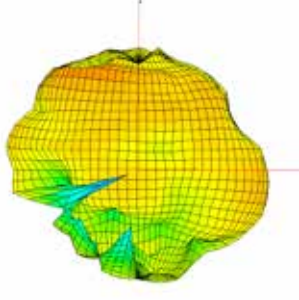
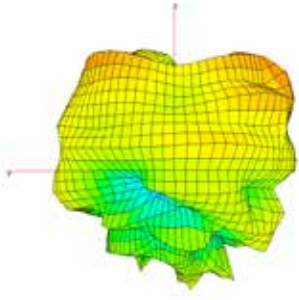
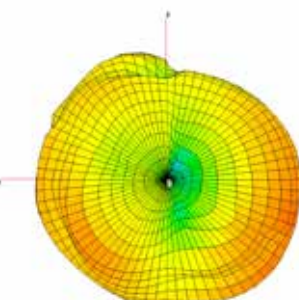
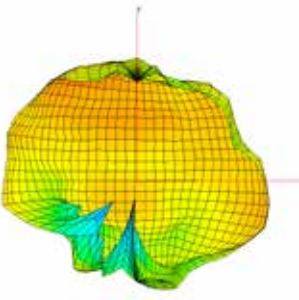
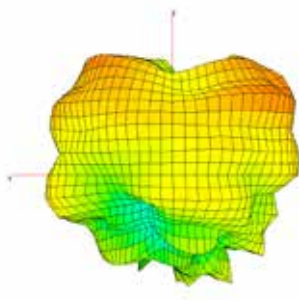
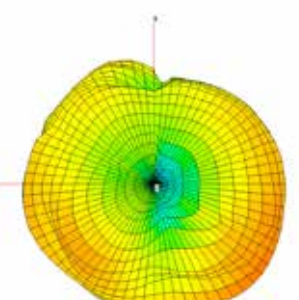
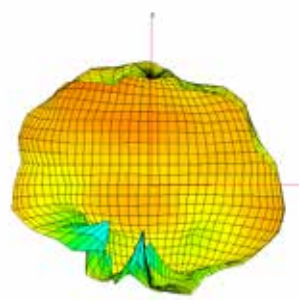
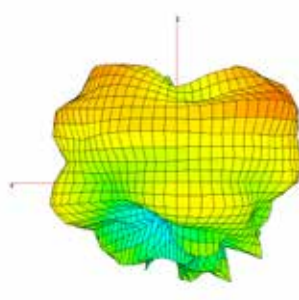
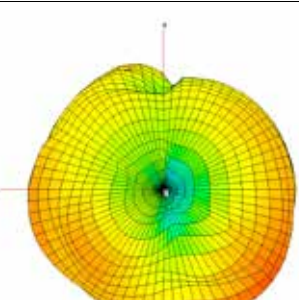
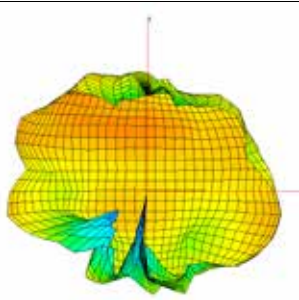
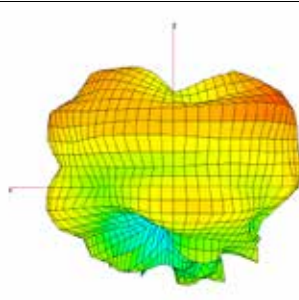
1842.45			
1879.9			
1920			
1950			
1980			

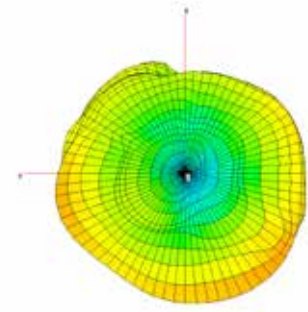
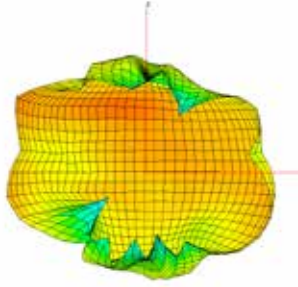
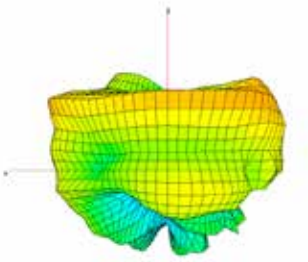
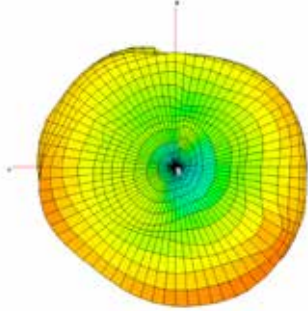
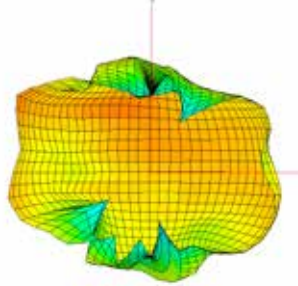
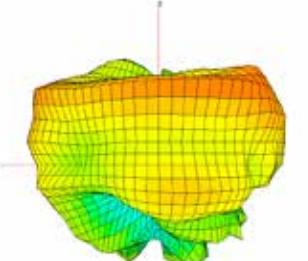
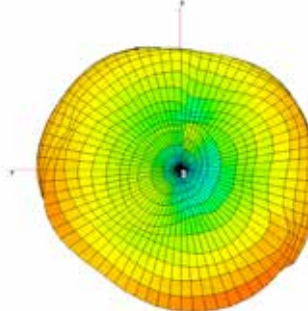
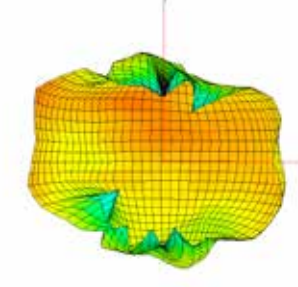
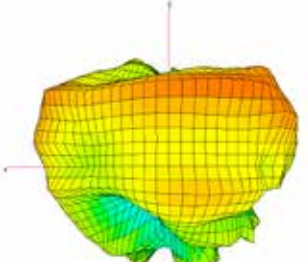
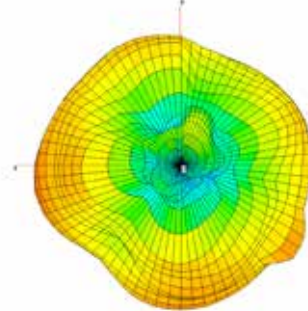
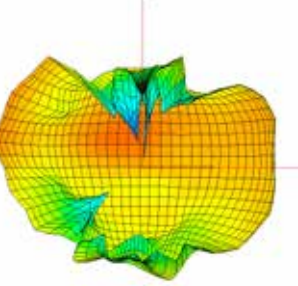
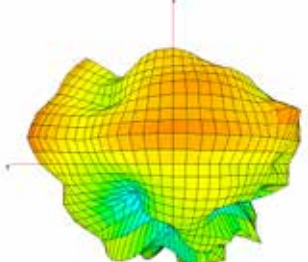
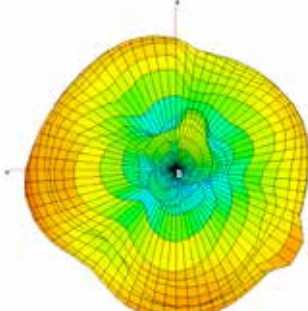
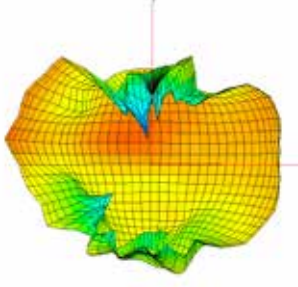
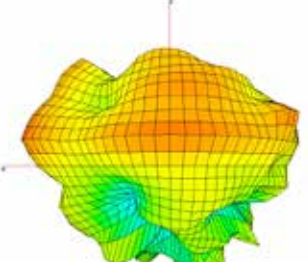

2110			
2140			
2170			
2330			
2350			

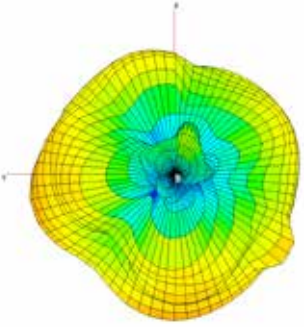
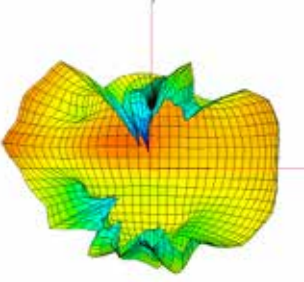
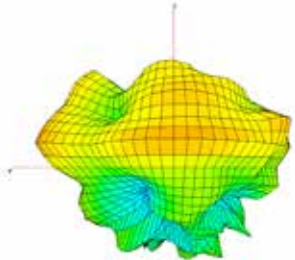
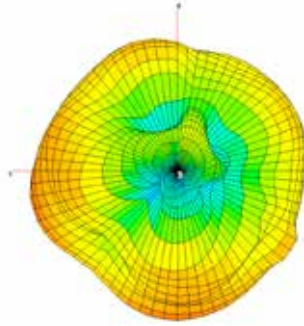
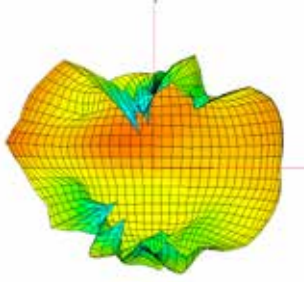
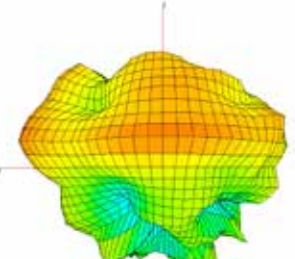
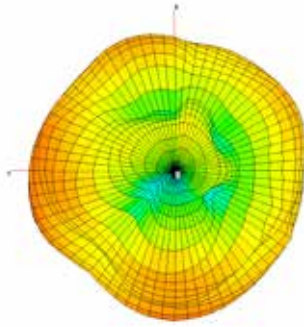
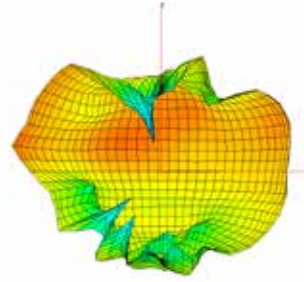
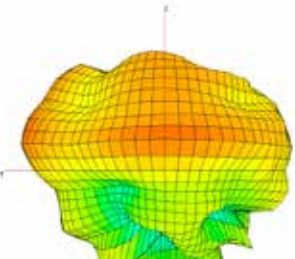
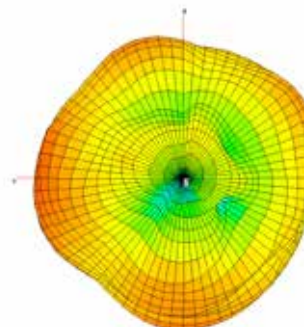
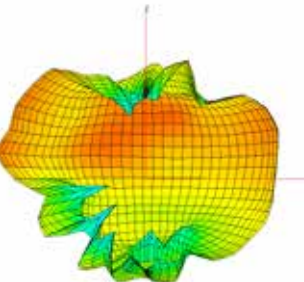
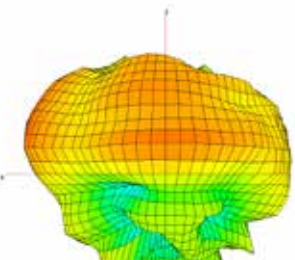
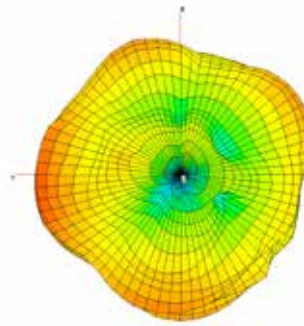
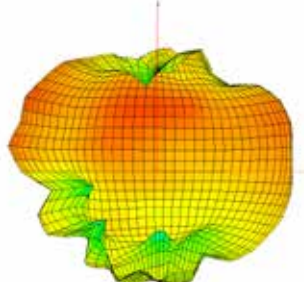
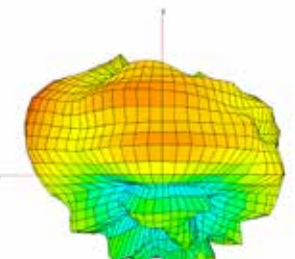
2370			
2401			
2449			
2497			
2545			

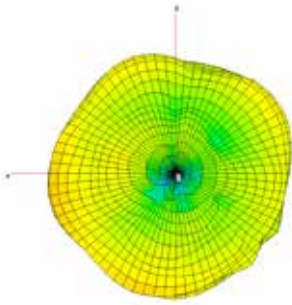
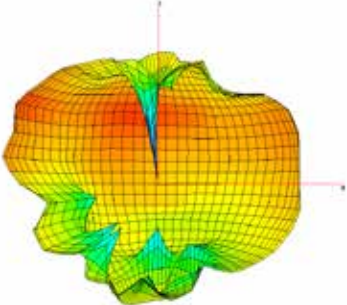
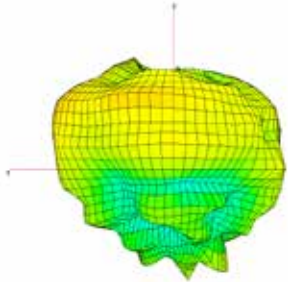
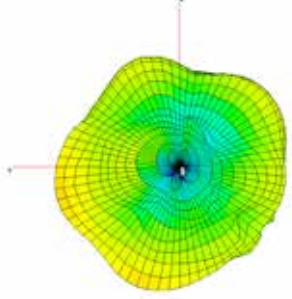
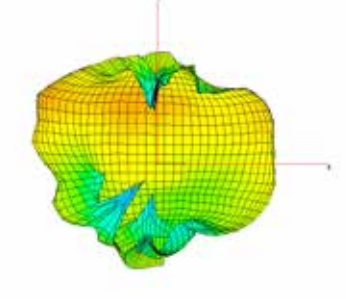
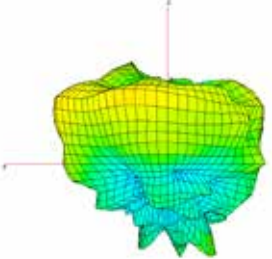
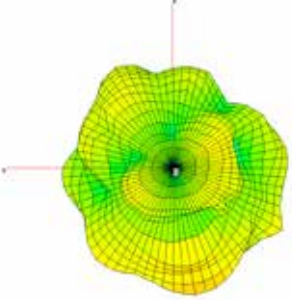
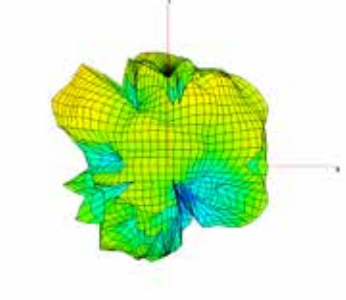
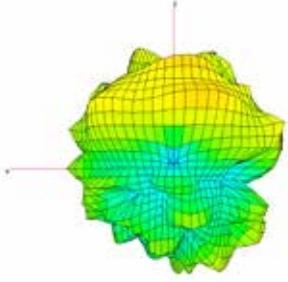
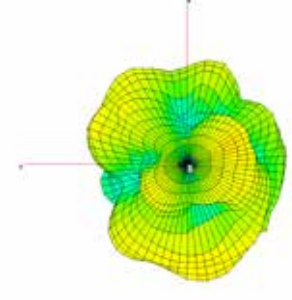
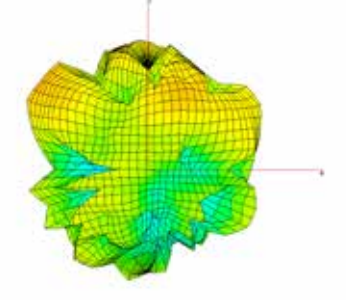
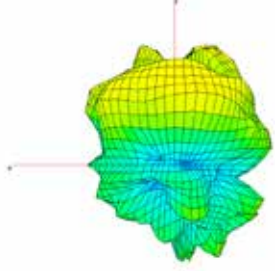
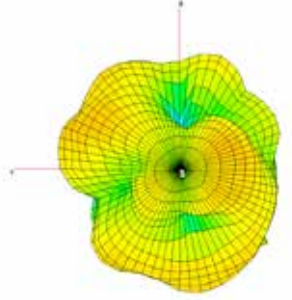
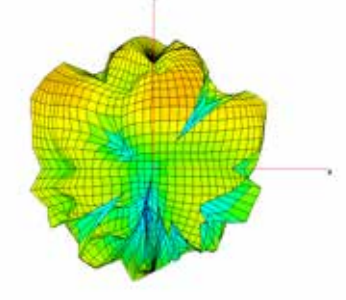
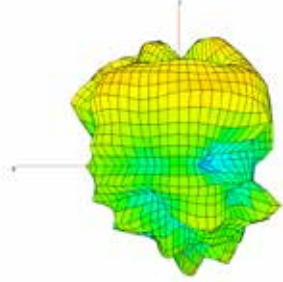

2595			
2645			
3400			
3500			
3600			

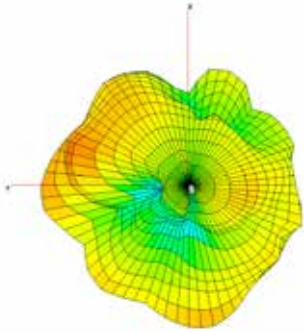
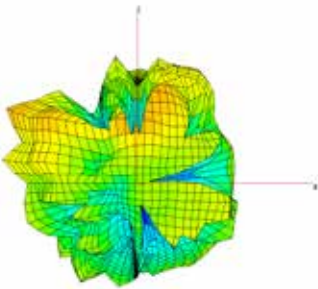
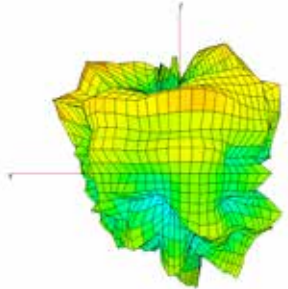
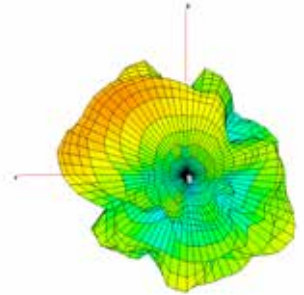
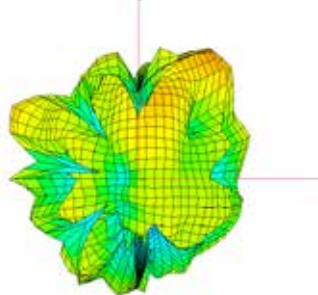
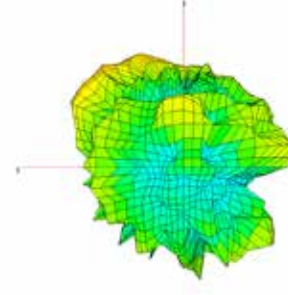
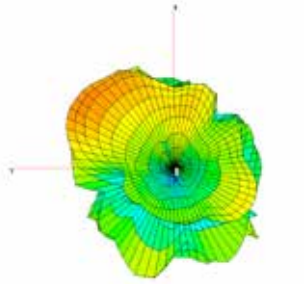
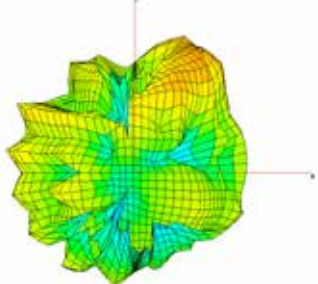
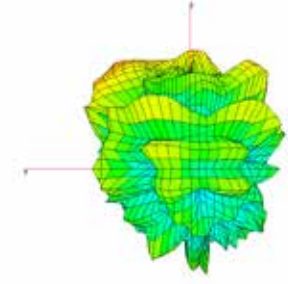
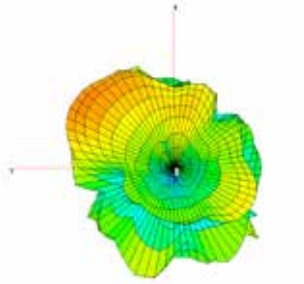
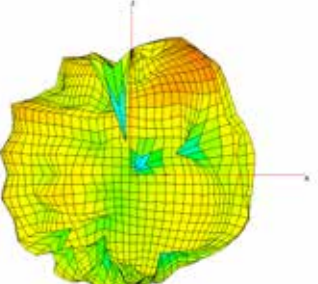
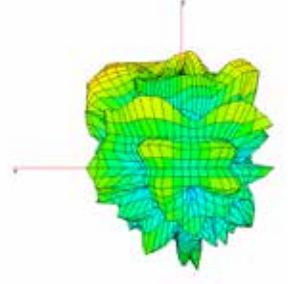
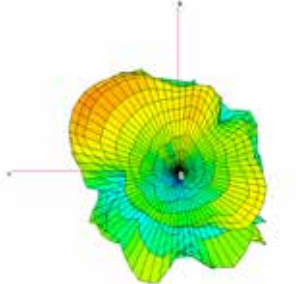
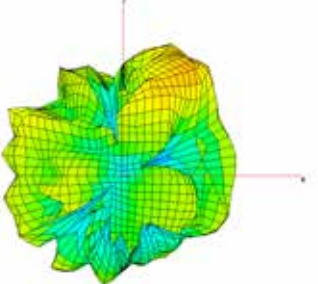
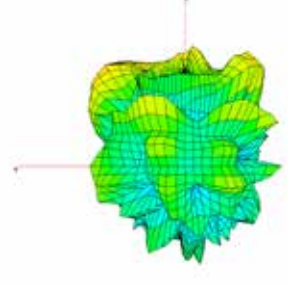
3850			
4100			
4500			
4550			
4600			

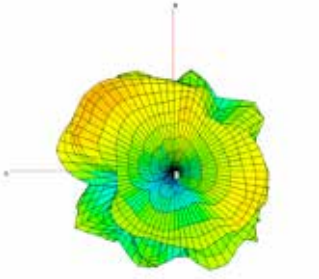
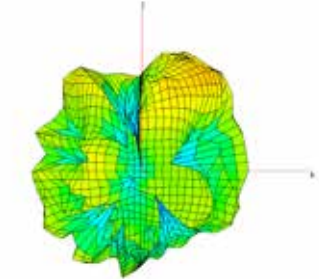
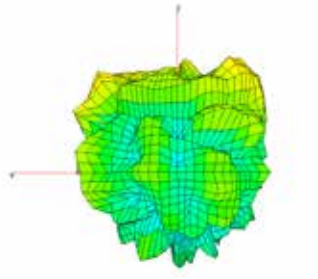
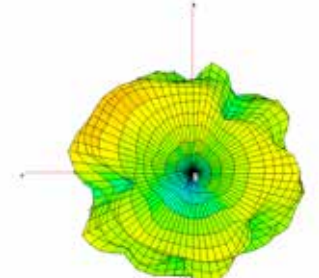
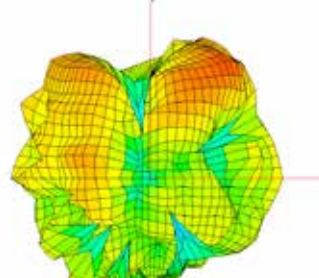
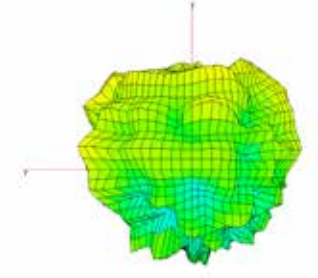
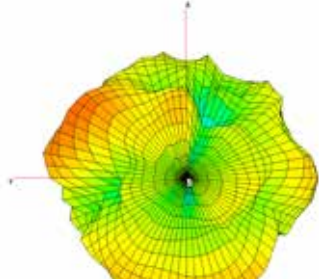
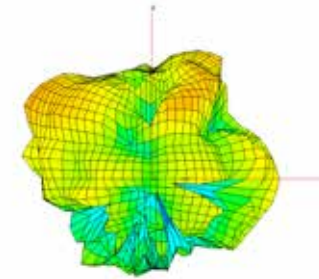
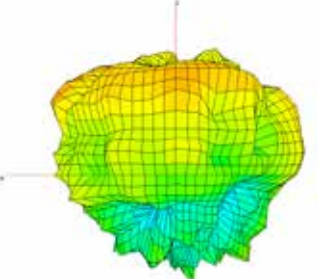
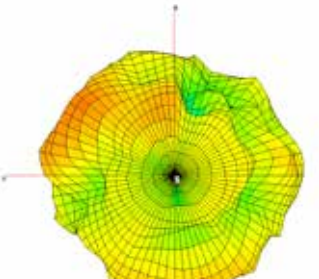
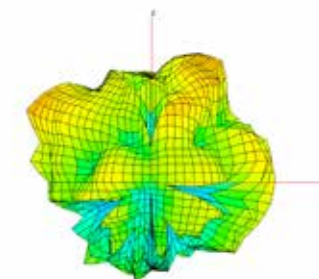
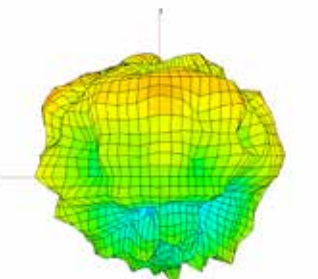
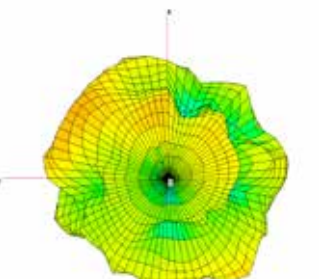
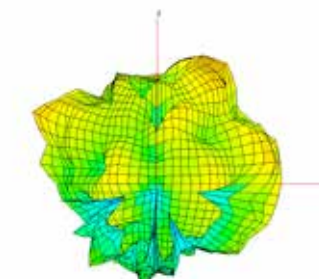
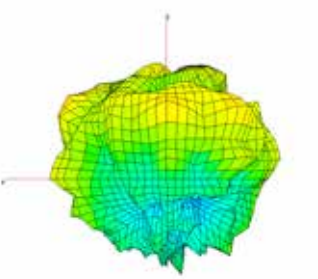
4750			
4900			
5170			
5250			
5330			

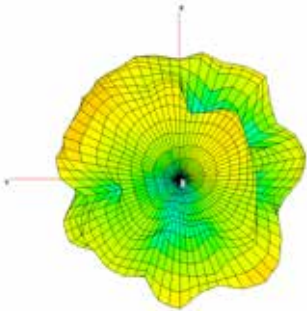
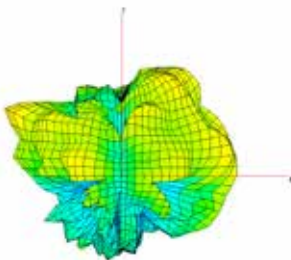
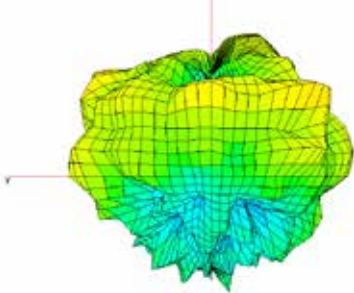
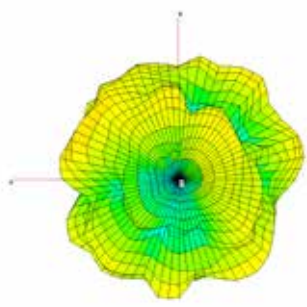
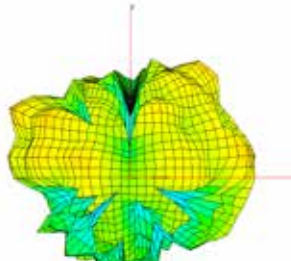
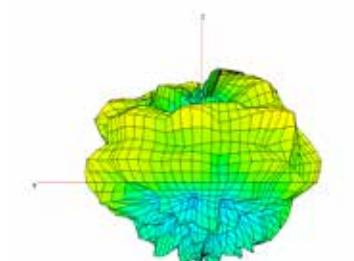
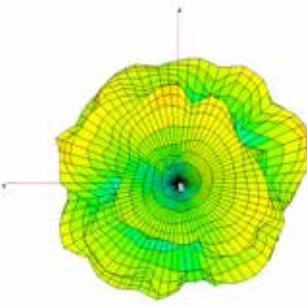
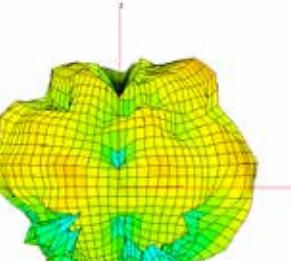
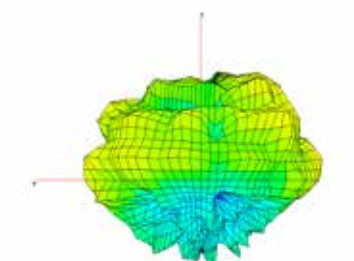

5490			
5610			
5730			
5945	