



測定日	2025年2月14日
測定場所	公益財団法人 福岡県産業・科学技術振興財団 社会システム実証センター（福岡県糸島市）
評価状況	<p>評価内容 RTA827（以下被評価アンテナ）の放射パターンおよび最大放射方向の利得をマルチアキスポジショニングシステムにより測定。（地板として 20cm 四方のアルミ板を使用）被評価アンテナケーブル長 0.45m・SMAP コネクター付き</p> <p>注：RTA825 と MG825 は取付け方法が異なるのみで、電気的特性は同一ケーブル損失データを元に各ケーブル長におけるアンテナ利得を算出</p>
測定周波数 (MHz)	<p>715、731.5、748、770、786.5</p> <p>803、815、830、845、860、875、890</p> <p>900、907.5、915、945、952.5、960</p> <p>1427.9、1445.4、1462.9、1475.9、1493.4</p> <p>1510.9、1575.42</p> <p>1710、1747.45、1784.9</p> <p>1805、1842.45、1879.9</p> <p>1920、1950、1980</p> <p>2110、2140、2170</p> <p>2330、2350、2370</p> <p>2401、2449、2497</p> <p>2545、2595、2645</p> <p>3400、3500、3600、3850</p> <p>4100、4500、4550、4600、4750、4900</p> <p>5170、5250、5330、5490、5610、5730、5945</p>

アンテナ納入仕様書

1. 一般事項	
1-1 適用範囲	この規格は、マグネットアンテナ (MG827- * -SMAP) の機械的性能および、電気的性能について適用する。
2. 外観・寸法	
2-1 外観	外観は裸眼で約 30cm 離し、機能上有害な錆、割れ、傷等がない事とする。
2-2 寸法	寸法 8.0x4.7x9.3cm (ケーブル含まず)
3. 機械的性能	
3-1 塩水噴霧試験	JIS Z2371 の中性塩水噴霧試験 72 時間に準拠 電気的特性と機械的特性に異常を認めない
3-2 ケーブル引張強度	1.5D-QFB(又は相当品) に 98N の静荷重を加えてケーブルが破断しないこと。但し、コネクタとアンテナの接続部を除く。
3-3 使用・保存温度範囲	-30℃～ 85℃の温度範囲内にて外観に変形・割れがなく、電気的特性を満足すること。
4. 電気的性能	
4-1 試験状況	
4-2 V.S.W.R.	28(n28) (715 ~ 748) " (770 ~ 803) 18(n18) (815 ~ 830) " (860 ~ 875) 19(n5) (830 ~ 845) " (875 ~ 890) 8(n8) (900 ~ 915) " (945 ~ 960) 11(n74) (1427.9 ~ 1447.9) 21(n74) (1447.9 ~ 1462.9) 11(n74) (1475.9 ~ 1495.9) 21(n74) (1495.9 ~ 1510.9) GPS (1575.42) 3(n3) (1710 ~ 1725) " (1730 ~ 1784.9) " (1805 ~ 1865) " (1859.9 ~ 1879.9) 1(n1) (1920 ~ 1980) " (2110 ~ 2170) n40 (2330 ~ 2370) Wifi (2401 ~ 2497) n41 (2545 ~ 2645) 42(n78) (3400 ~ 3600) n77,n78(3600 ~ 4000) " (4000 ~ 4100) n79 (4500 ~ 4900) Wifi (5170 ~ 5330) " (5490 ~ 5730) " (5945 ~ 6425) .5GHz 帯 (Band11,21) 3.0 : 1 以下 その他の使用周波数帯 2.0 : 1 以下 (1.5DX-FB ケーブル 2.5m のとき)
14-3 入力インピーダンス	50 Ω
4-4 利得	使用周波数範囲において 3dBi 以下 ケーブル長制限 : 利得を 3dBi 以下とするために、1.5DXB 2.5m 相当以上のロス (900MHz で 1.5dB) を有するケーブルを使用する

アンテナ仕様

仕様項目		仕様内容
1	型名	MG827-* -SMAP MG827-(ケーブル長)-(コネクタの型式)を示す。 5mの場合、MG827-5-SMAP
2	品名	ルーフトップアンテナ
3	使用周波数 (MHz)	28(n28) (715 ~ 748) " (770 ~ 803) 18(n18) (815 ~ 830) " (860 ~ 875) 19(n5) (830 ~ 845) " (875 ~ 890) 8(n8) (900 ~ 915) " (945 ~ 960) 11(n74) (1427.9 ~ 1447.9) 21(n74) (1447.9 ~ 1462.9) 11(n74) (1475.9 ~ 1495.9) 21(n74) (1495.9 ~ 1510.9) GPS (1575.42) 3(n3) (1710 ~ 1725) " (1730 ~ 1784.9) " (1805 ~ 1865) " (1859.9 ~ 1879.9) 1(n1) (1920 ~ 1980) " (2110 ~ 2170) n40 (2330 ~ 2370) Wifi (2401 ~ 2497) n41 (2545 ~ 2645) 42(n78) (3400 ~ 3600) n77,n78(3600 ~ 4000) " (4000 ~ 4100) n79 (4500 ~ 4900) Wifi (5170 ~ 5330) " (5490 ~ 5730) " (5945 ~ 6425)
4	形式	単一型 (V) 1/4 λ
5	入力インピーダンス	50 Ω
6	定在波比	1.5GHz 帯 (Band11,21) 3.0 : 1 以下 その他の使用周波数帯 2.0 : 1 以下 (1.5DXB ケーブル 2.5m のとき)
7	放射パターン特性	水平面内指向性 無指向性
8	絶縁抵抗	給電端子乾燥時 DC500V にて 500M Ω 以上
9	耐電圧	給電端子乾燥時 AC1000V、1 分間加えて異常なき事
10	接続端子	SMA-P 型
11	アンテナ部寸法	外観図参照
12	質量 (ケーブル含まず)	約 90g
13	取付け方法	マグネット吸着

外觀図

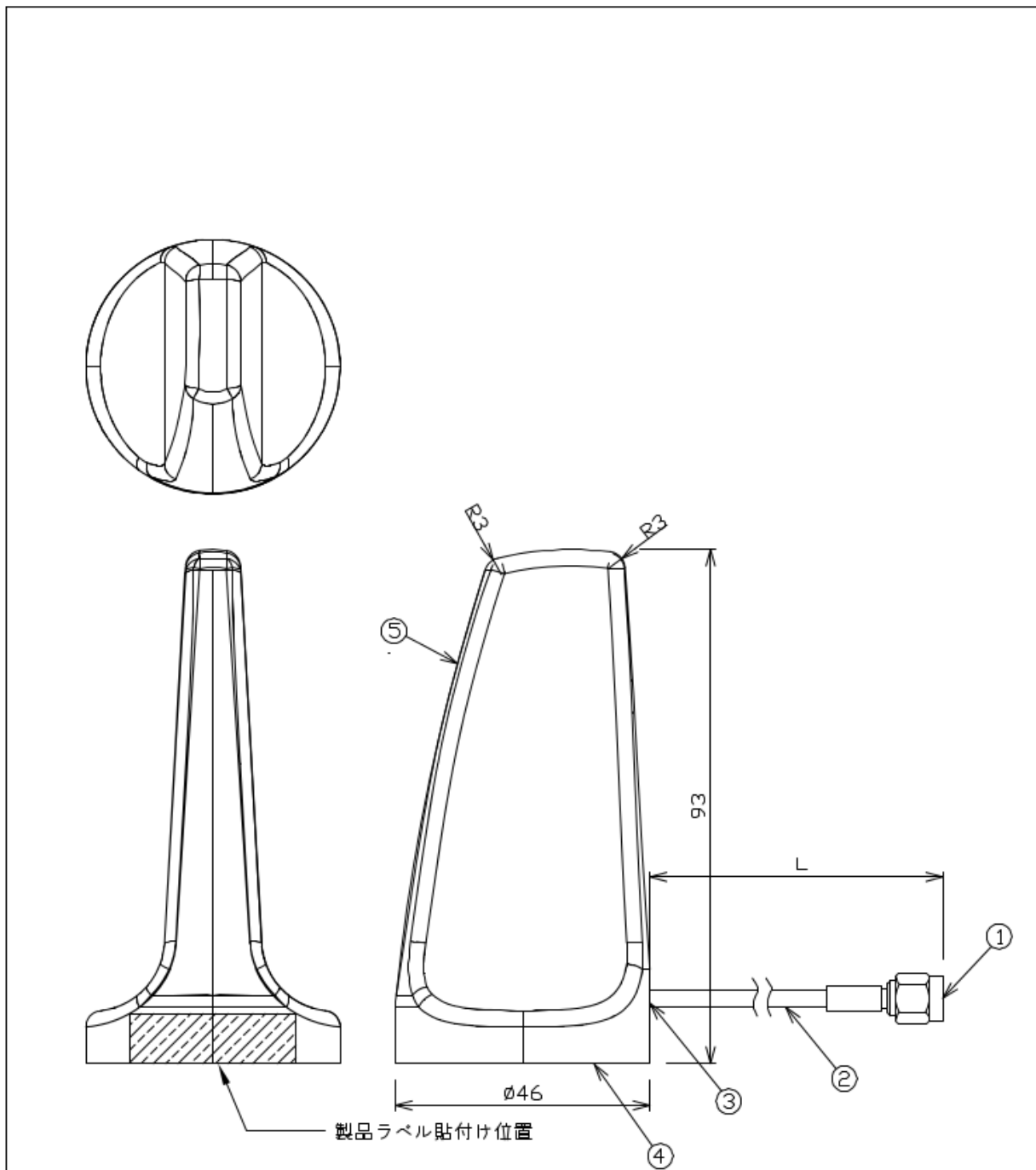

L
****mm±3%

5	アンテナレドーム	ABS	黒	尺度	単位	SAGA DENSHI KOGYO CO.,LTD.	
4	キャップマグネット	Fe	三価クロメート	図番	図名		
3	グロメット	NPE	黒	2022012602	MG827-＊-SMAP 外觀図		
2	1.5DX-FB (又は相当品)	PVC	黒	新宅	今泉	FILE NAME	
1	SMA-P型	Bs	メッキ仕上げ	設計	製図	MG827外觀図.dwg	
部番	部品名	材質	備考	設計	製図	検印	

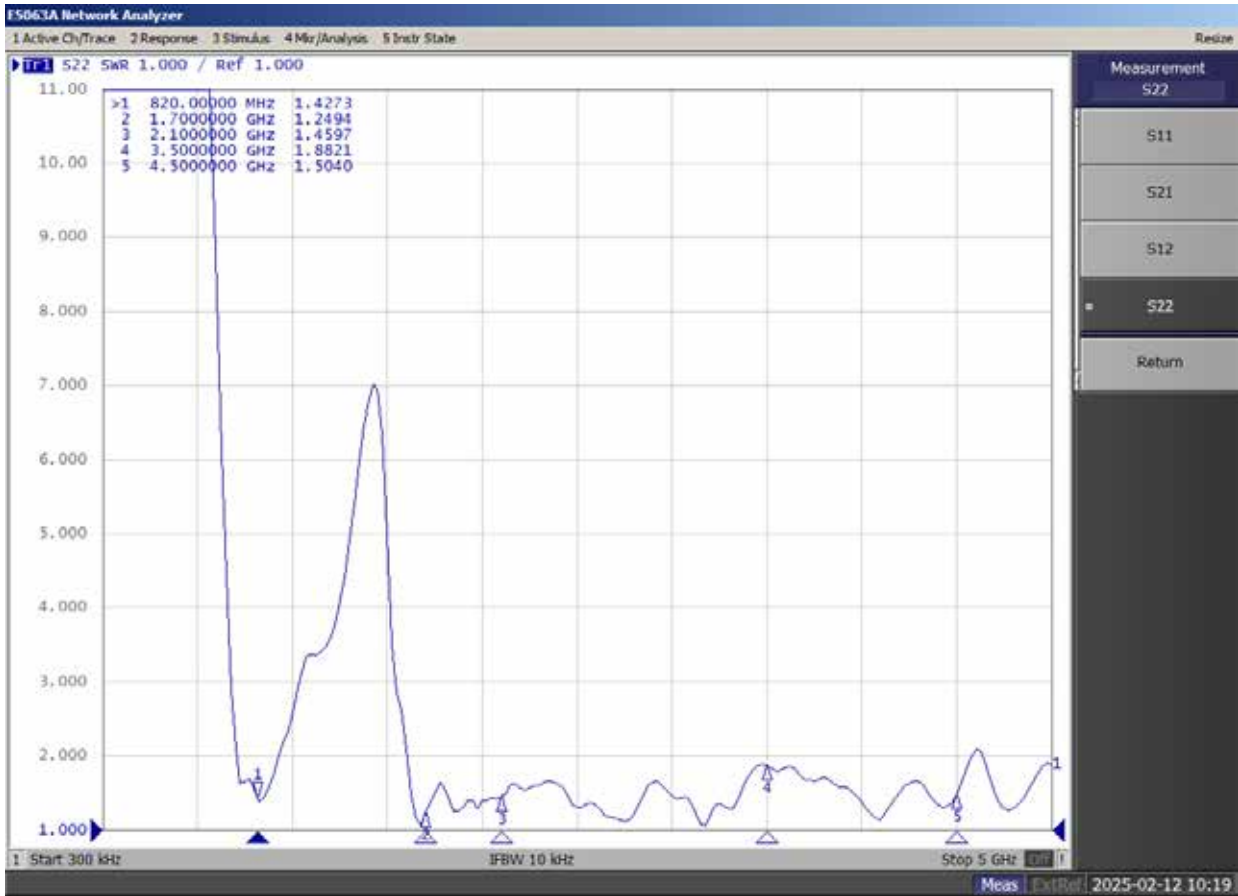

周波数 (MHz)	RTA827(MG827)- *-SMAP 利得(dBi) * : ケーブル長(m)					
	1m	2m	2.5m	3m	5m	10m
715	-1.37	-1.92	-2.19	-2.46	-3.56	-6.31
731.5	-0.77	-1.31	-1.59	-1.86	-2.94	-5.66
748	-0.04	-0.59	-0.86	-1.13	-2.23	-4.97
770	1.09	0.53	0.25	-0.02	-1.14	-3.94
786.5	1.80	1.23	0.94	0.66	-0.48	-3.32
803	1.37	0.79	0.50	0.21	-0.94	-3.83
815	1.51	0.93	0.64	0.35	-0.82	-3.74
830	1.70	1.11	0.82	0.52	-0.65	-3.60
845	1.73	1.14	0.85	0.55	-0.62	-3.56
860	1.87	1.29	0.99	0.70	-0.48	-3.42
875	1.73	1.14	0.84	0.54	-0.65	-3.62
890	1.82	1.22	0.91	0.61	-0.61	-3.64
900	1.66	1.05	0.74	0.44	-0.79	-3.84
907.5	1.44	0.82	0.52	0.21	-1.02	-4.09
915	1.40	0.78	0.47	0.16	-1.07	-4.16
945	1.41	0.78	0.46	0.14	-1.12	-4.29
952.5	1.43	0.79	0.47	0.16	-1.12	-4.31
960	1.61	0.98	0.66	0.35	-0.91	-4.06
1427.9	-1.56	-2.36	-2.76	-3.17	-4.78	-8.80
1445.4	-1.81	-2.62	-3.03	-3.43	-5.05	-9.09
1462.9	-1.64	-2.43	-2.83	-3.22	-4.81	-8.78
1475.9	-1.30	-2.10	-2.50	-2.90	-4.50	-8.51
1493.4	-0.71	-1.52	-1.93	-2.34	-3.97	-8.05
1510.9	-0.29	-1.12	-1.53	-1.95	-3.60	-7.75
1575.42	0.87	0.03	-0.40	-0.82	-2.50	-6.72
1710	2.59	1.70	1.26	0.82	-0.96	-5.38
1747.45	2.92	2.02	1.57	1.12	-0.67	-5.15
1784.9	5.19	4.29	3.83	3.38	1.57	-2.96
1805	5.50	4.58	4.12	3.66	1.82	-2.78
1842.45	4.39	3.47	3.01	2.55	0.71	-3.88
1879.9	3.18	2.24	1.77	1.30	-0.58	-5.28
1920	3.15	2.21	1.73	1.26	-0.64	-5.37
1950	2.94	1.98	1.50	1.02	-0.90	-5.71
1980	3.15	2.17	1.69	1.20	-0.74	-5.59
2110	3.23	2.23	1.73	1.23	-0.76	-5.75
2140	3.33	2.33	1.83	1.33	-0.67	-5.67
2170	3.47	2.45	1.94	1.43	-0.60	-5.69
2330	4.77	3.70	3.16	2.62	0.48	-4.89
2350	4.98	3.91	3.38	2.84	0.71	-4.63
2370	4.88	3.80	3.26	2.72	0.56	-4.84
2401	4.23	3.15	2.62	2.08	-0.07	-5.45
2449	4.49	3.38	2.83	2.27	0.06	-5.47
2497	5.10	3.99	3.43	2.88	0.66	-4.89
2545	4.90	3.76	3.20	2.63	0.36	-5.32
2595	4.41	3.27	2.71	2.14	-0.13	-5.80
2645	4.59	3.45	2.89	2.32	0.05	-5.62
3400	3.82	2.52	1.87	1.22	-1.37	-7.85
3500	4.27	2.93	2.25	1.58	-1.12	-7.87
3600	4.60	3.17	2.46	1.75	-1.10	-8.21
3850	5.39	3.96	3.24	2.53	-0.33	-7.49
4100	6.58	5.07	4.32	3.57	0.55	-6.98
4500	4.99	3.38	2.57	1.77	-1.46	-9.54
4550	4.51	2.93	2.14	1.35	-1.82	-9.73
4600	4.26	2.65	1.85	1.05	-2.16	-10.18
4750	2.55	0.91	0.08	-0.74	-4.03	-12.24

4900	2.76	1.08	0.24	-0.60	-3.96	-12.35
5170	0.78	-0.97	-1.85	-2.72	-6.22	-14.97
5250	2.30	0.50	-0.41	-1.31	-4.91	-13.92
5330	3.14	1.37	0.48	-0.40	-3.95	-12.81
5490	1.79	-0.05	-0.96	-1.88	-5.55	-14.74
5610	2.46	0.58	-0.35	-1.29	-5.05	-14.45
5730	2.15	0.21	-0.76	-1.73	-5.61	-15.32
5945	2.44	0.52	-0.44	-1.40	-5.25	-14.86

RTA827(MG827) 指向性特性

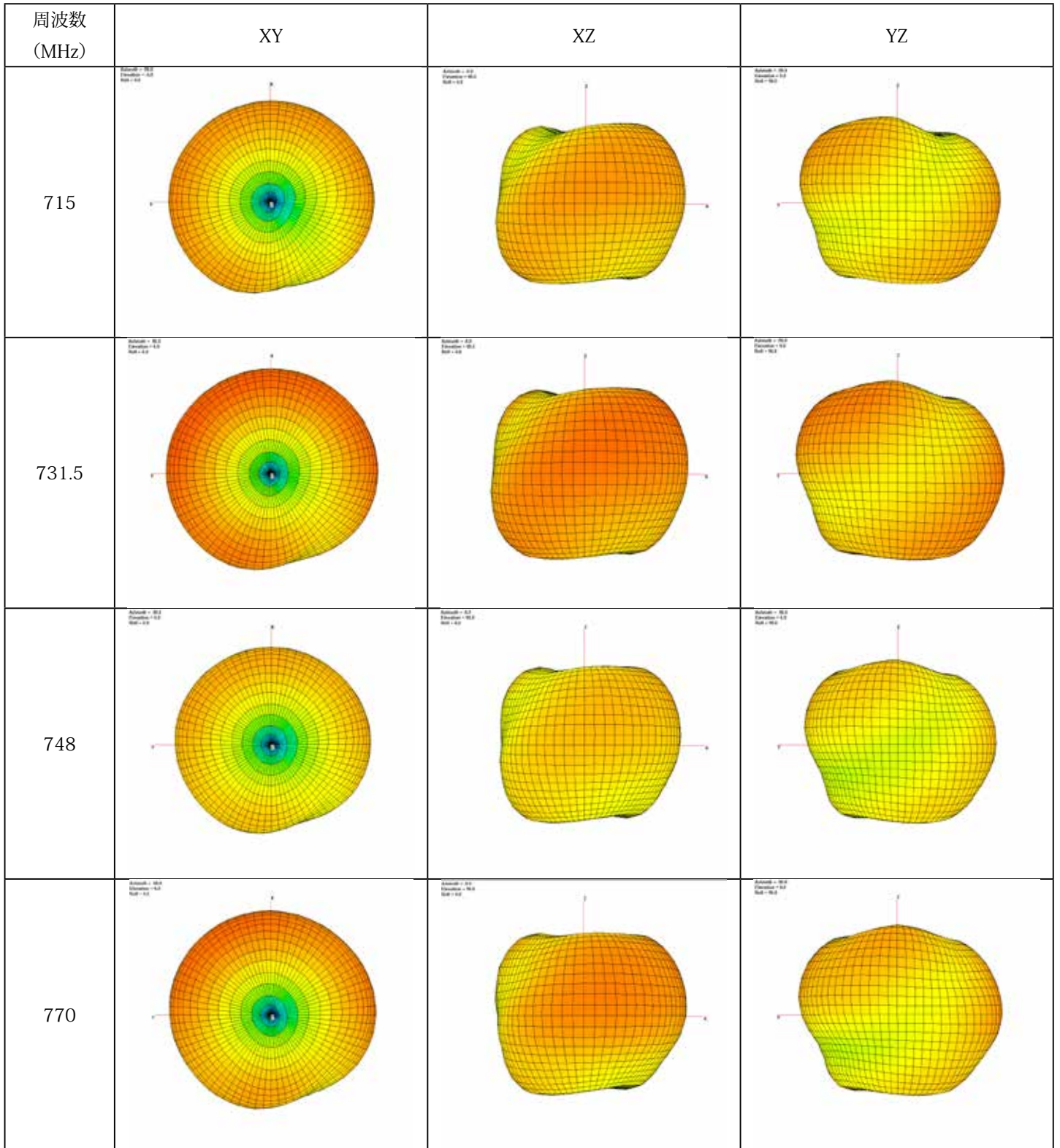

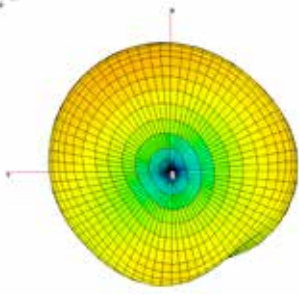
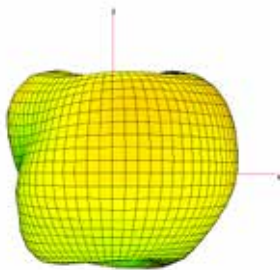
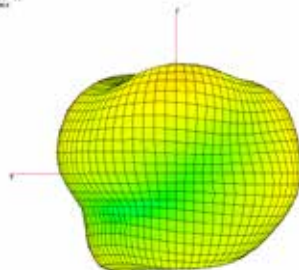
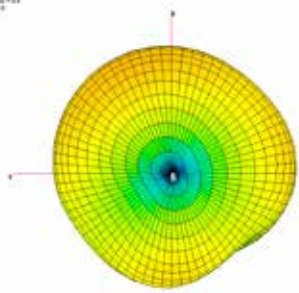
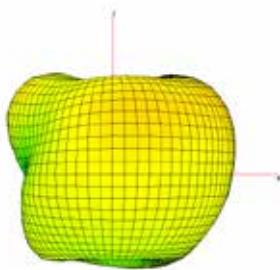
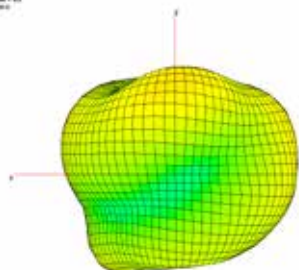
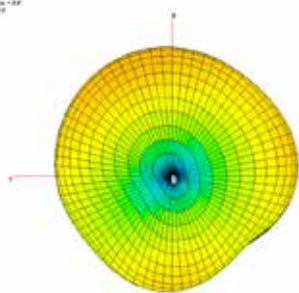
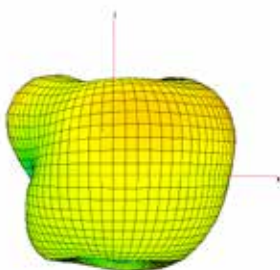
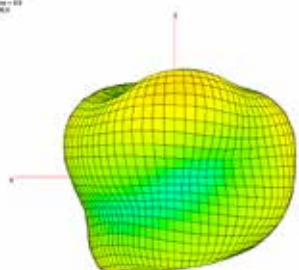
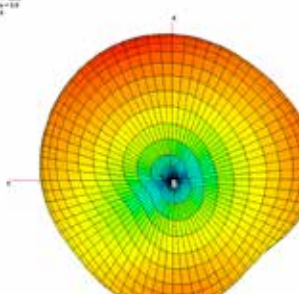
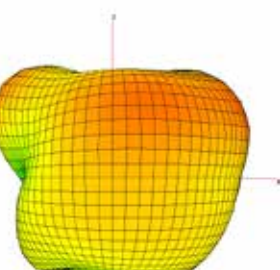
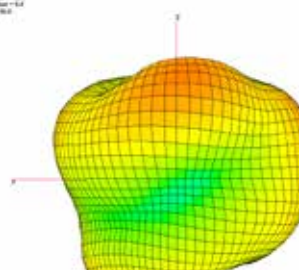
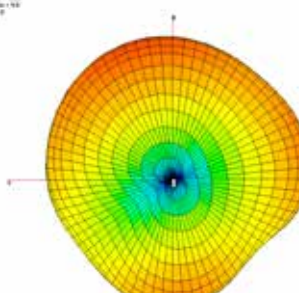
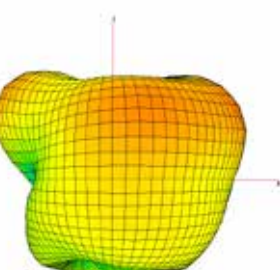
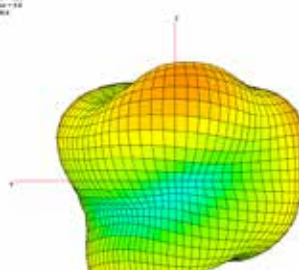
860	<p>Amplitude: 0.02 Excitation: 1.00 RMS: 1.00</p> 	<p>Amplitude: 0.01 Excitation: 0.80 RMS: 1.00</p> 	<p>Amplitude: 0.01 Excitation: 1.00 RMS: 1.00</p> 
875	<p>Amplitude: 0.02 Excitation: 1.00 RMS: 1.00</p> 	<p>Amplitude: 0.01 Excitation: 0.80 RMS: 1.00</p> 	<p>Amplitude: 0.01 Excitation: 1.00 RMS: 1.00</p> 
890	<p>Amplitude: 0.02 Excitation: 1.00 RMS: 1.00</p> 	<p>Amplitude: 0.01 Excitation: 0.80 RMS: 1.00</p> 	<p>Amplitude: 0.01 Excitation: 1.00 RMS: 1.00</p> 
900	<p>Amplitude: 0.02 Excitation: 1.00 RMS: 1.00</p> 	<p>Amplitude: 0.01 Excitation: 0.80 RMS: 1.00</p> 	<p>Amplitude: 0.01 Excitation: 1.00 RMS: 1.00</p> 
907.5	<p>Amplitude: 0.02 Excitation: 1.00 RMS: 1.00</p> 	<p>Amplitude: 0.01 Excitation: 0.80 RMS: 1.00</p> 	<p>Amplitude: 0.01 Excitation: 1.00 RMS: 1.00</p> 

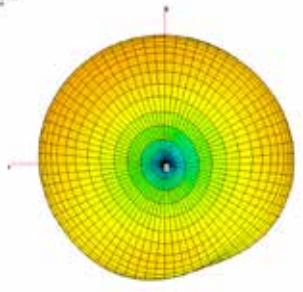
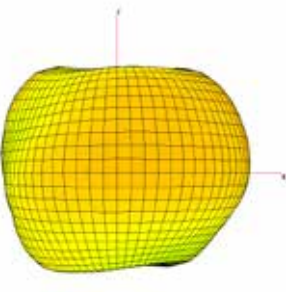
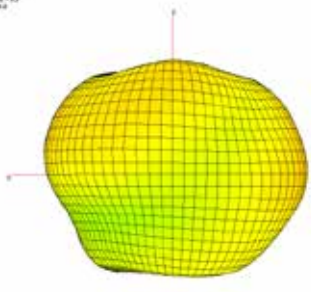
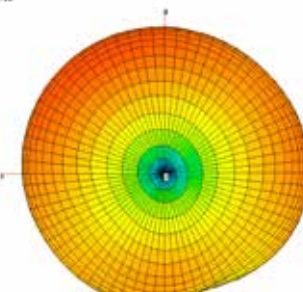
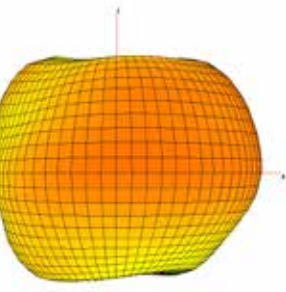
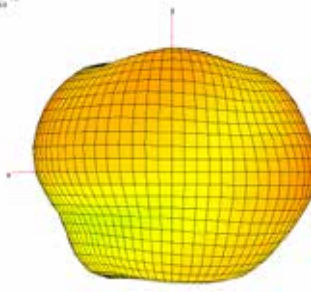
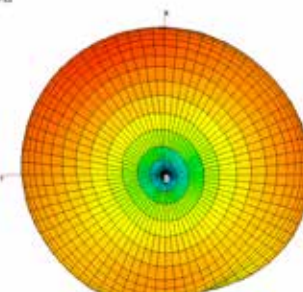
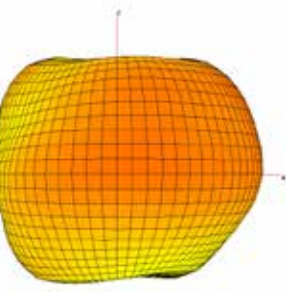
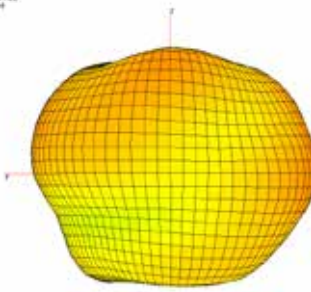
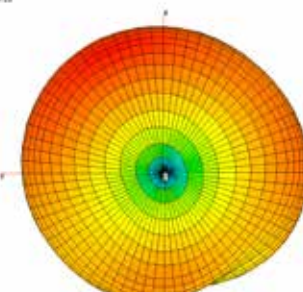
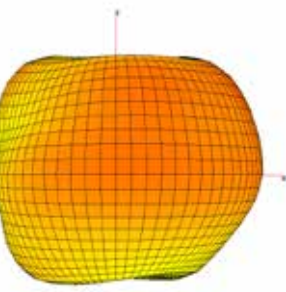
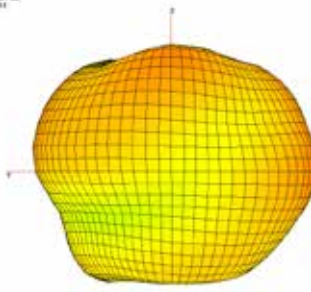
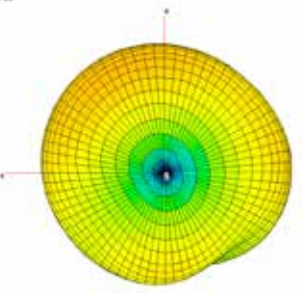
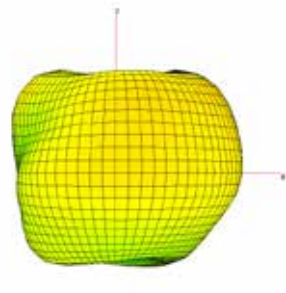
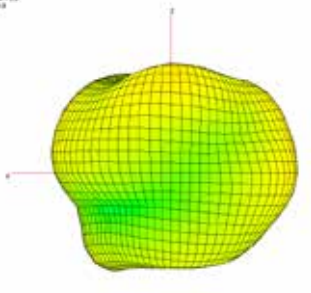
786.5	<p>Amplitude: 0.02 Dimension: 1.0 Mesh: 1.0</p> 	<p>Amplitude: 0.02 Dimension: 0.5 Mesh: 1.0</p> 	<p>Amplitude: 0.02 Dimension: 1.0 Mesh: 1.0</p> 
803	<p>Amplitude: 0.02 Dimension: 1.0 Mesh: 1.0</p> 	<p>Amplitude: 0.02 Dimension: 0.5 Mesh: 1.0</p> 	<p>Amplitude: 0.02 Dimension: 1.0 Mesh: 1.0</p> 
815	<p>Amplitude: 0.02 Dimension: 1.0 Mesh: 1.0</p> 	<p>Amplitude: 0.02 Dimension: 0.5 Mesh: 1.0</p> 	<p>Amplitude: 0.02 Dimension: 1.0 Mesh: 1.0</p> 
830	<p>Amplitude: 0.02 Dimension: 1.0 Mesh: 1.0</p> 	<p>Amplitude: 0.02 Dimension: 0.5 Mesh: 1.0</p> 	<p>Amplitude: 0.02 Dimension: 1.0 Mesh: 1.0</p> 
845	<p>Amplitude: 0.02 Dimension: 1.0 Mesh: 1.0</p> 	<p>Amplitude: 0.02 Dimension: 0.5 Mesh: 1.0</p> 	<p>Amplitude: 0.02 Dimension: 1.0 Mesh: 1.0</p> 

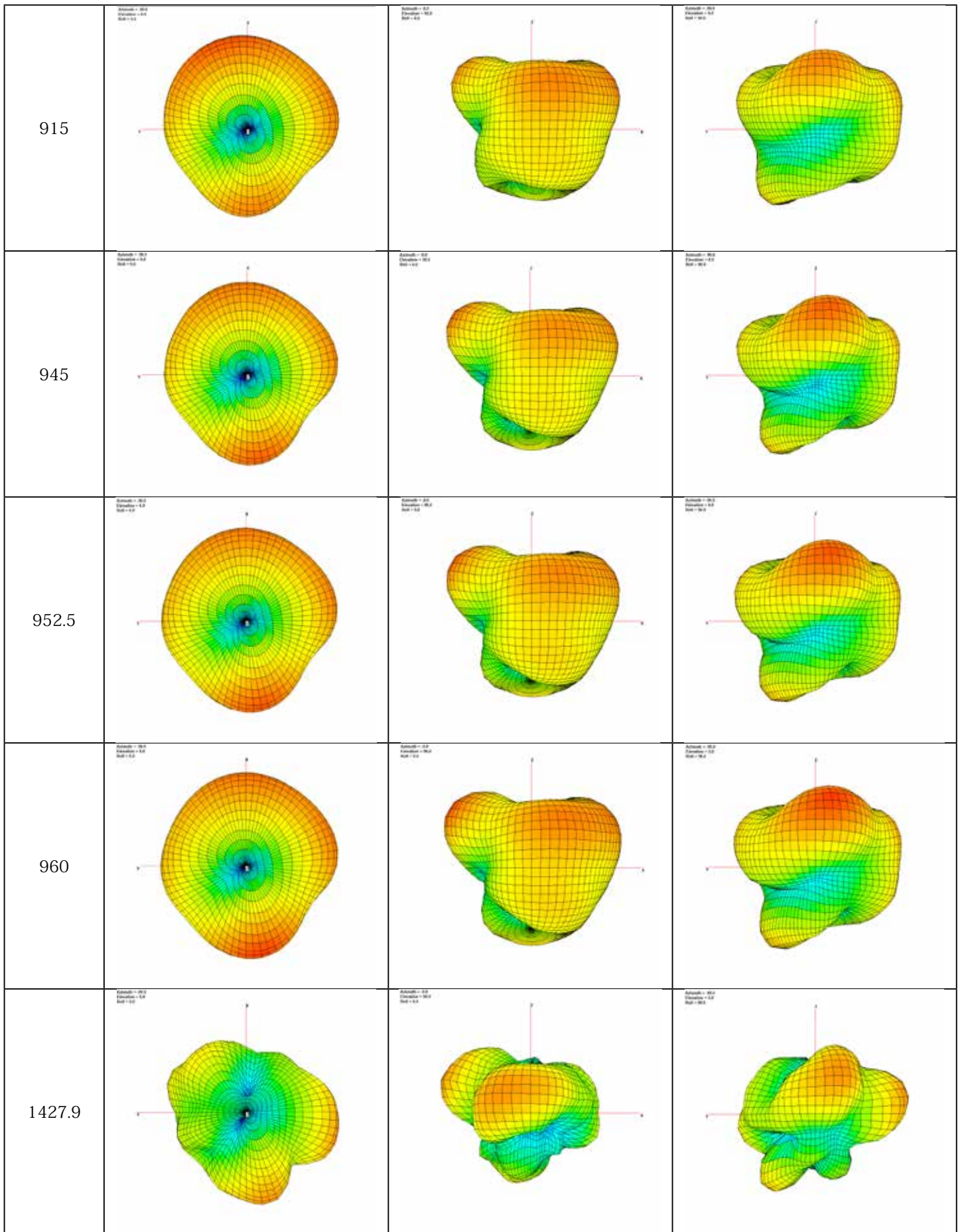

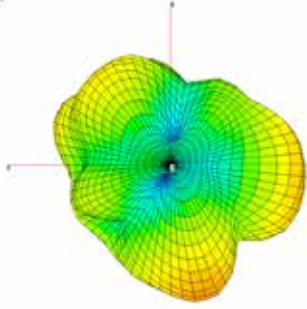
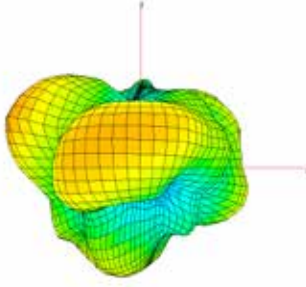
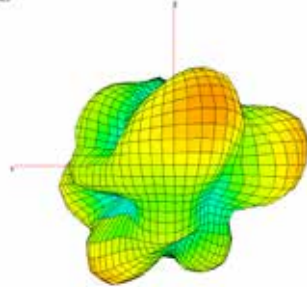
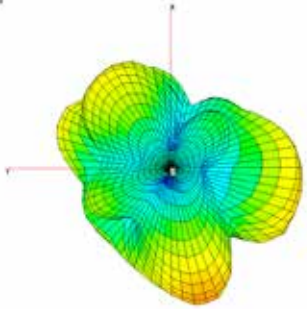
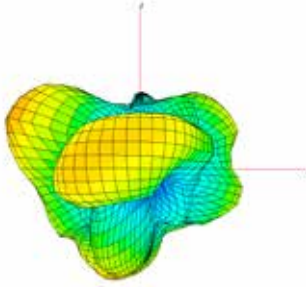
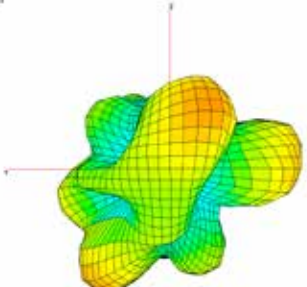
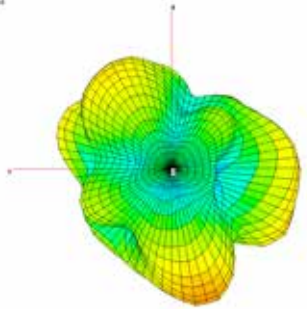
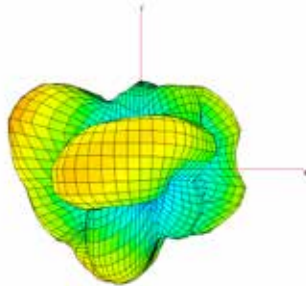
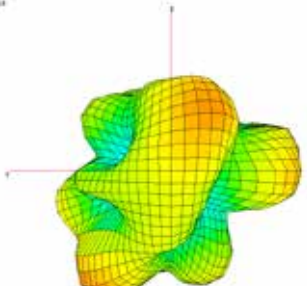
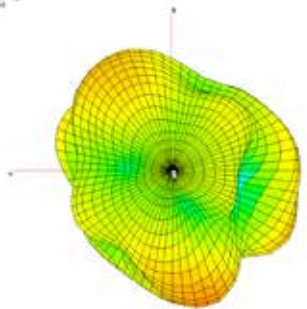
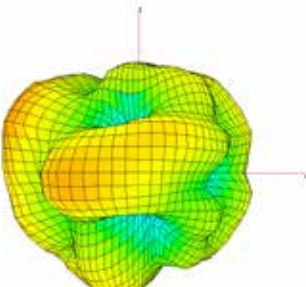
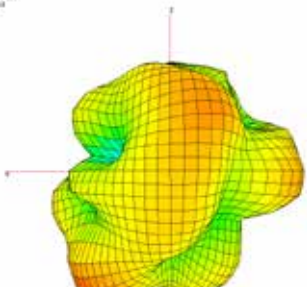
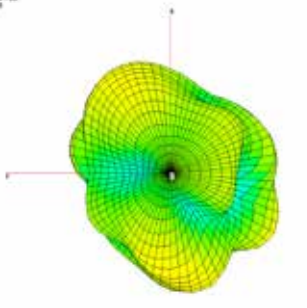
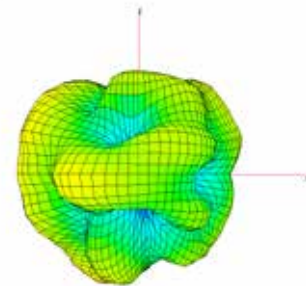
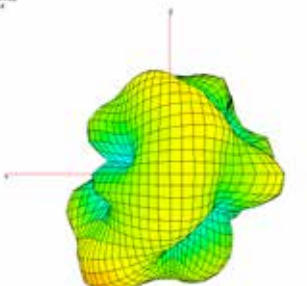
1445.4	<p>Amplitude: 0.02 Frequency: 0.0 Scale: 1.0</p> 	<p>Amplitude: 0.02 Frequency: 0.0 Scale: 1.0</p> 	<p>Amplitude: 0.02 Frequency: 0.0 Scale: 1.0</p> 
1462.9	<p>Amplitude: 0.02 Frequency: 0.0 Scale: 1.0</p> 	<p>Amplitude: 0.02 Frequency: 0.0 Scale: 1.0</p> 	<p>Amplitude: 0.02 Frequency: 0.0 Scale: 1.0</p> 
1475.9	<p>Amplitude: 0.02 Frequency: 0.0 Scale: 1.0</p> 	<p>Amplitude: 0.02 Frequency: 0.0 Scale: 1.0</p> 	<p>Amplitude: 0.02 Frequency: 0.0 Scale: 1.0</p> 
1493.4	<p>Amplitude: 0.02 Frequency: 0.0 Scale: 1.0</p> 	<p>Amplitude: 0.02 Frequency: 0.0 Scale: 1.0</p> 	<p>Amplitude: 0.02 Frequency: 0.0 Scale: 1.0</p> 
1510.9	<p>Amplitude: 0.02 Frequency: 0.0 Scale: 1.0</p> 	<p>Amplitude: 0.02 Frequency: 0.0 Scale: 1.0</p> 	<p>Amplitude: 0.02 Frequency: 0.0 Scale: 1.0</p> 

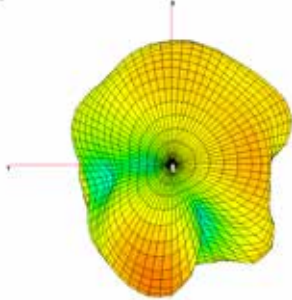
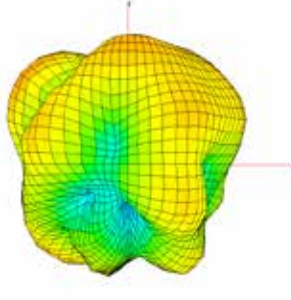
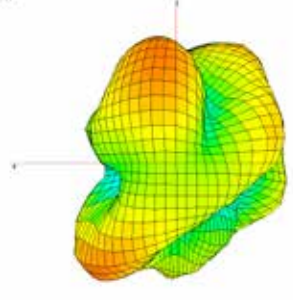
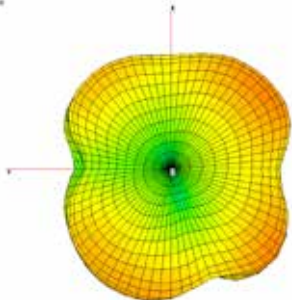
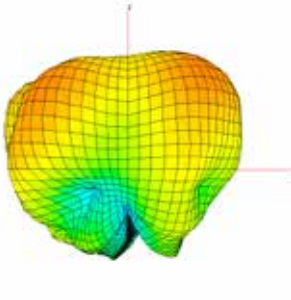
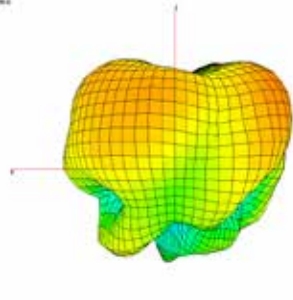
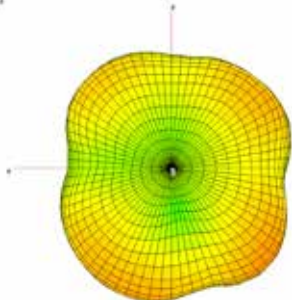
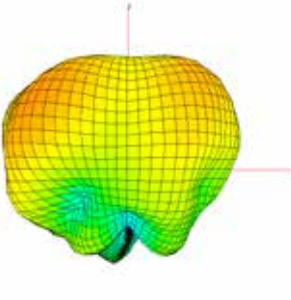
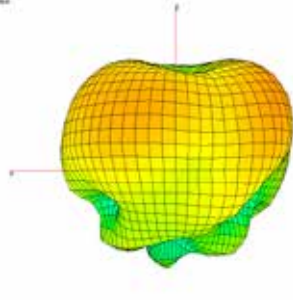
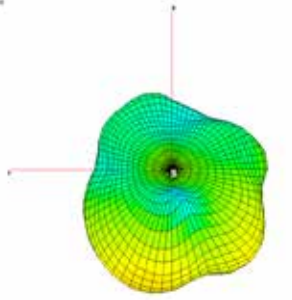
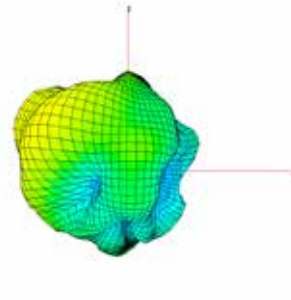
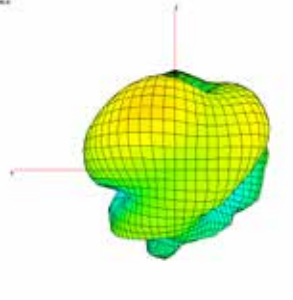
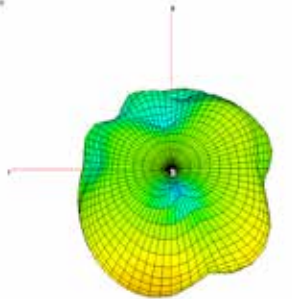
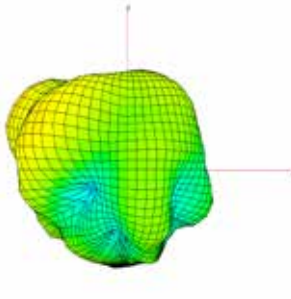
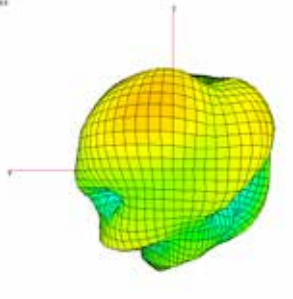
1575.42	<p>Amplitude = 0.2 Frequency = 0.2 Refr = 1.0</p> 	<p>Amplitude = 0.2 Frequency = 0.2 Refr = 1.0</p> 	<p>Amplitude = 0.2 Frequency = 0.2 Refr = 1.0</p> 
1710	<p>Amplitude = 0.2 Frequency = 1.0 Refr = 1.0</p> 	<p>Amplitude = 0.2 Frequency = 1.0 Refr = 1.0</p> 	<p>Amplitude = 0.2 Frequency = 1.0 Refr = 1.0</p> 
1747.45	<p>Amplitude = 0.2 Frequency = 1.0 Refr = 1.0</p> 	<p>Amplitude = 0.2 Frequency = 1.0 Refr = 1.0</p> 	<p>Amplitude = 0.2 Frequency = 1.0 Refr = 1.0</p> 
1784.9	<p>Amplitude = 0.2 Frequency = 1.0 Refr = 1.0</p> 	<p>Amplitude = 0.2 Frequency = 1.0 Refr = 1.0</p> 	<p>Amplitude = 0.2 Frequency = 1.0 Refr = 1.0</p> 
1805	<p>Amplitude = 0.2 Frequency = 1.0 Refr = 1.0</p> 	<p>Amplitude = 0.2 Frequency = 1.0 Refr = 1.0</p> 	<p>Amplitude = 0.2 Frequency = 1.0 Refr = 1.0</p> 

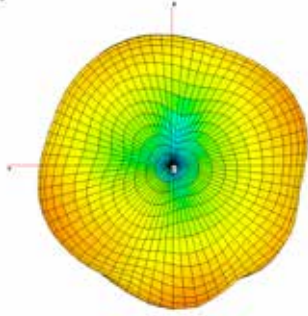
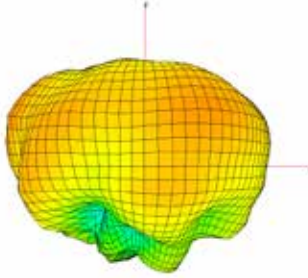
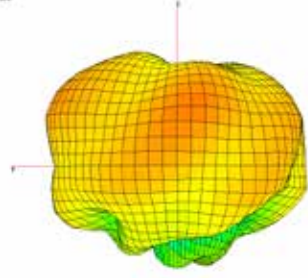
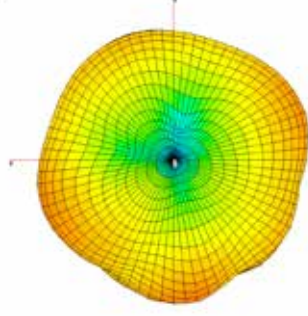
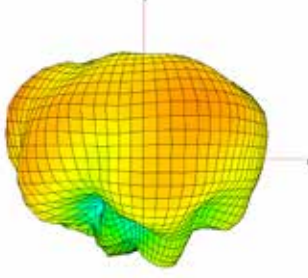
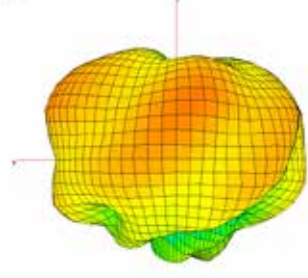
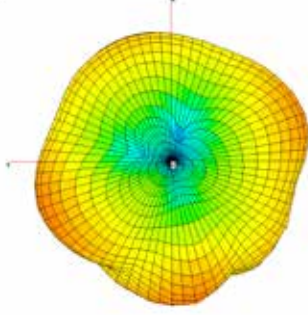
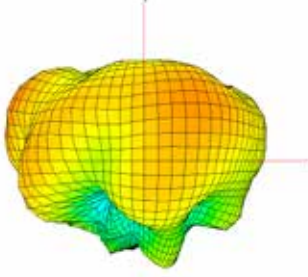
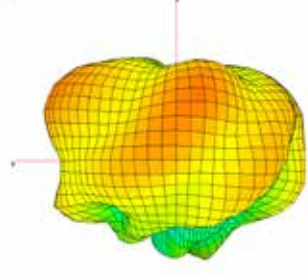
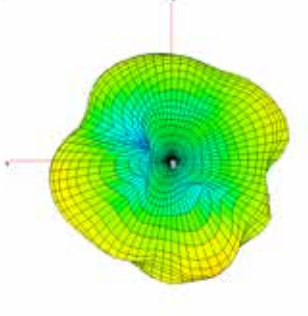
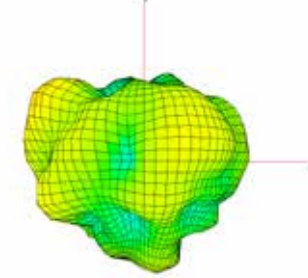
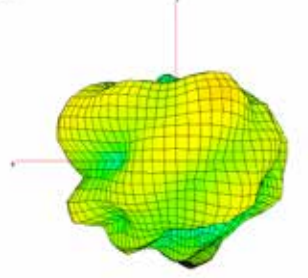
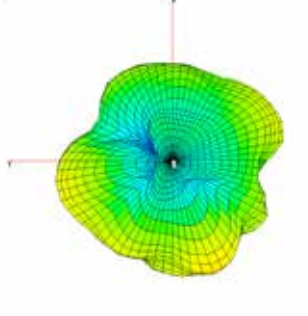
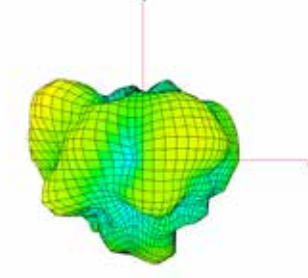
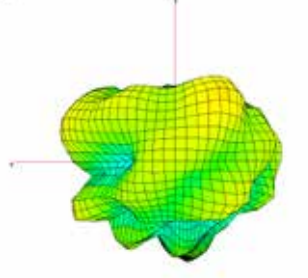
2110	<p>Amplitude: 0.2 Excitation: 1.00 Refr: 1.00</p> 	<p>Amplitude: 0.2 Excitation: 1.00 Refr: 1.00</p> 	<p>Amplitude: 0.2 Excitation: 1.00 Refr: 1.00</p> 
2140	<p>Amplitude: 0.2 Excitation: 1.00 Refr: 1.00</p> 	<p>Amplitude: 0.2 Excitation: 1.00 Refr: 1.00</p> 	<p>Amplitude: 0.2 Excitation: 1.00 Refr: 1.00</p> 
2170	<p>Amplitude: 0.2 Excitation: 1.00 Refr: 1.00</p> 	<p>Amplitude: 0.2 Excitation: 1.00 Refr: 1.00</p> 	<p>Amplitude: 0.2 Excitation: 1.00 Refr: 1.00</p> 
2330	<p>Amplitude: 0.2 Excitation: 1.00 Refr: 1.00</p> 	<p>Amplitude: 0.2 Excitation: 1.00 Refr: 1.00</p> 	<p>Amplitude: 0.2 Excitation: 1.00 Refr: 1.00</p> 
2350	<p>Amplitude: 0.2 Excitation: 1.00 Refr: 1.00</p> 	<p>Amplitude: 0.2 Excitation: 1.00 Refr: 1.00</p> 	<p>Amplitude: 0.2 Excitation: 1.00 Refr: 1.00</p> 

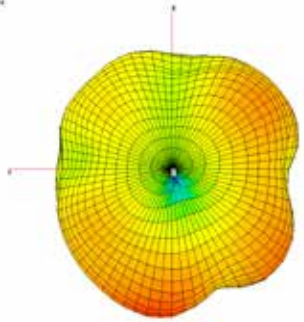
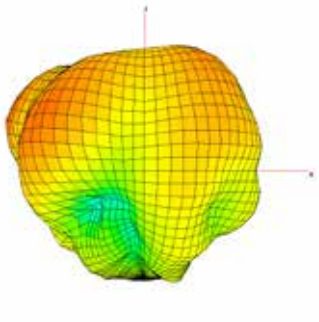
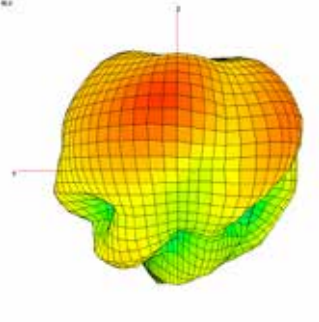
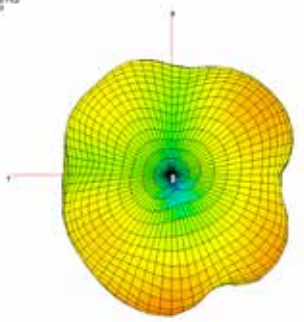
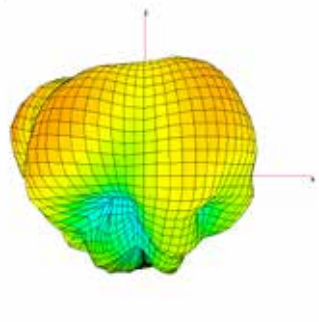
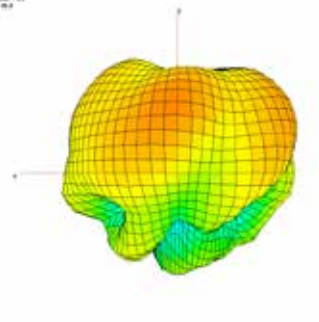
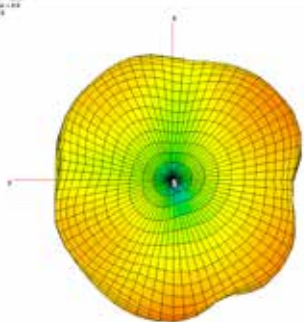
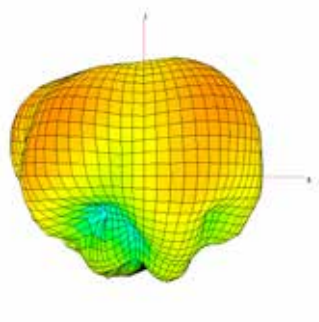
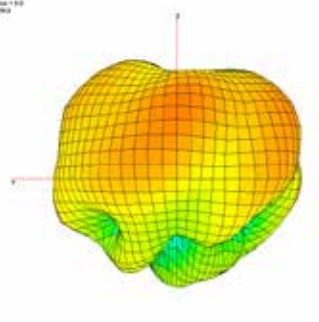
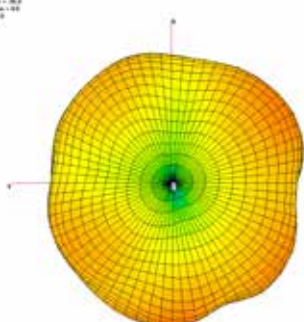
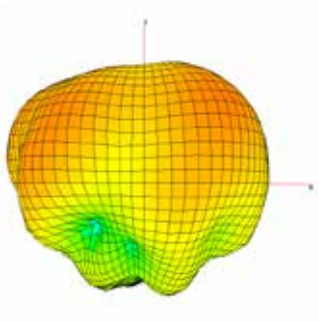
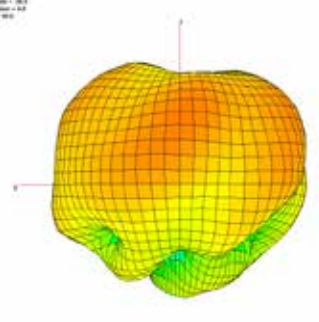
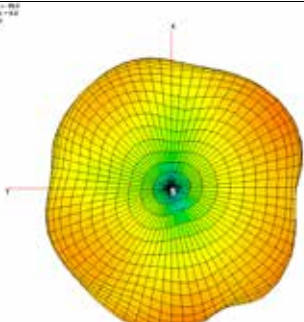
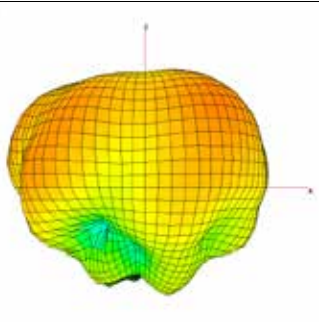
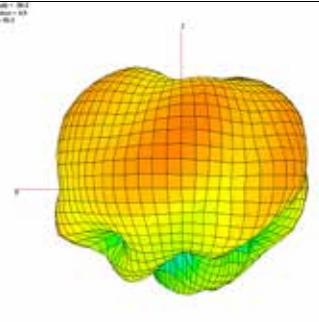
1842.45	<p>Iteration = 0.0 Eulerian = 0.0 Max = 1.00</p> 	<p>Iteration = 0.0 Eulerian = 0.0 Max = 1.00</p> 	<p>Iteration = 0.0 Eulerian = 0.0 Max = 1.00</p> 
1879.9	<p>Iteration = 0.0 Eulerian = 0.0 Max = 1.00</p> 	<p>Iteration = 0.0 Eulerian = 0.0 Max = 1.00</p> 	<p>Iteration = 0.0 Eulerian = 0.0 Max = 1.00</p> 
1920	<p>Iteration = 0.0 Eulerian = 0.0 Max = 1.00</p> 	<p>Iteration = 0.0 Eulerian = 0.0 Max = 1.00</p> 	<p>Iteration = 0.0 Eulerian = 0.0 Max = 1.00</p> 
1950	<p>Iteration = 0.0 Eulerian = 0.0 Max = 1.00</p> 	<p>Iteration = 0.0 Eulerian = 0.0 Max = 1.00</p> 	<p>Iteration = 0.0 Eulerian = 0.0 Max = 1.00</p> 
1980	<p>Iteration = 0.0 Eulerian = 0.0 Max = 1.00</p> 	<p>Iteration = 0.0 Eulerian = 0.0 Max = 1.00</p> 	<p>Iteration = 0.0 Eulerian = 0.0 Max = 1.00</p> 

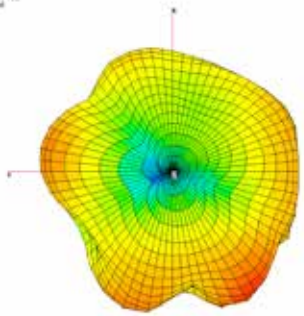
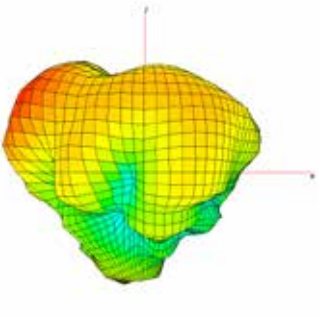
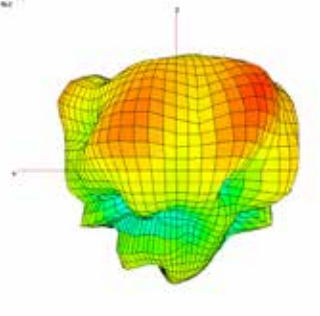
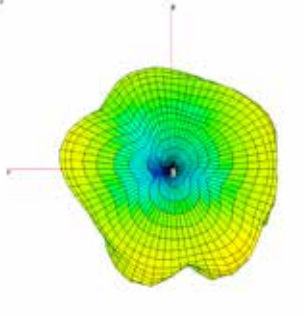
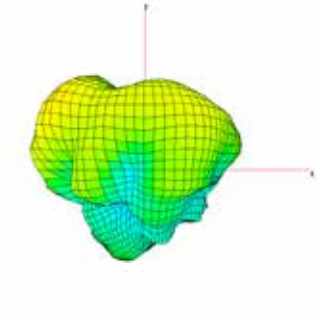
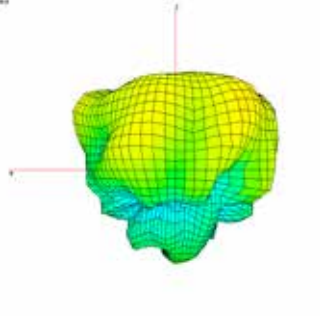
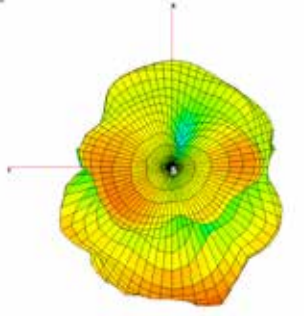
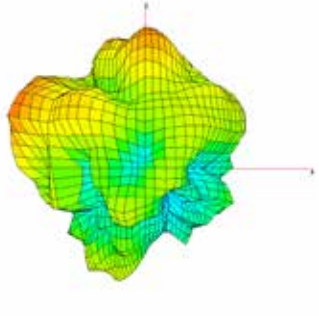
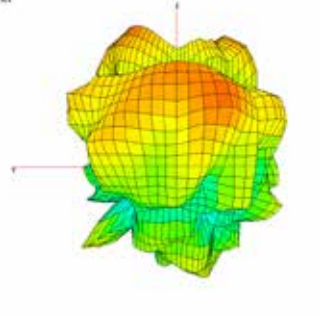
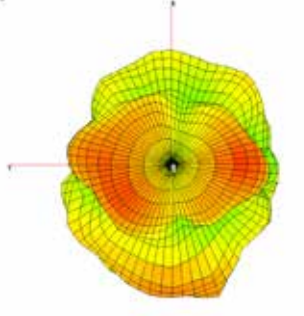
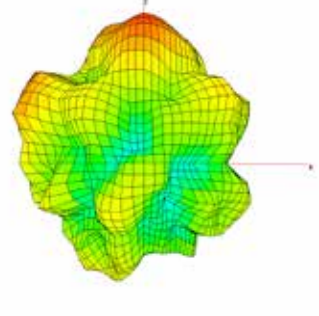
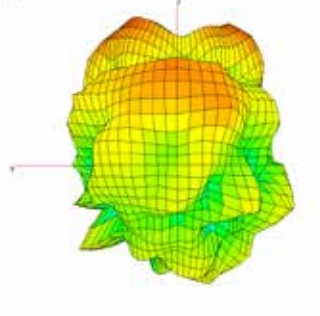
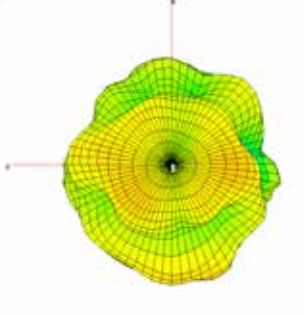
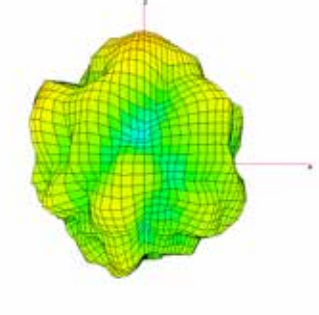
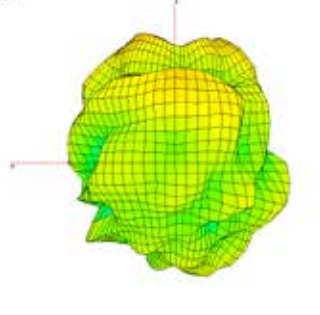
2595	<p>Amplitude: 0.02 Direction: +E2 Mode: +E2</p> 	<p>Amplitude: 0.02 Direction: +E2 Mode: +E2</p> 	<p>Amplitude: 0.02 Direction: +E2 Mode: +E2</p> 
2645	<p>Amplitude: 0.02 Direction: +E2 Mode: +E2</p> 	<p>Amplitude: 0.02 Direction: +E2 Mode: +E2</p> 	<p>Amplitude: 0.02 Direction: +E2 Mode: +E2</p> 
3400	<p>Amplitude: 0.02 Direction: +E2 Mode: +E2</p> 	<p>Amplitude: 0.02 Direction: +E2 Mode: +E2</p> 	<p>Amplitude: 0.02 Direction: +E2 Mode: +E2</p> 
3500	<p>Amplitude: 0.02 Direction: +E2 Mode: +E2</p> 	<p>Amplitude: 0.02 Direction: +E2 Mode: +E2</p> 	<p>Amplitude: 0.02 Direction: +E2 Mode: +E2</p> 
3600	<p>Amplitude: 0.02 Direction: +E2 Mode: +E2</p> 	<p>Amplitude: 0.02 Direction: +E2 Mode: +E2</p> 	<p>Amplitude: 0.02 Direction: +E2 Mode: +E2</p> 

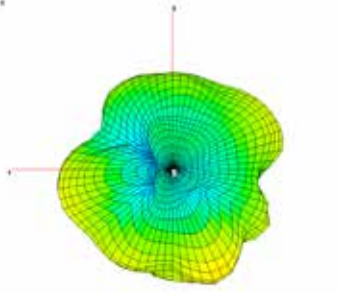
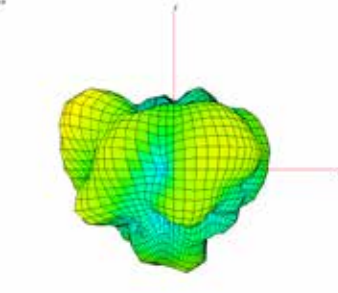
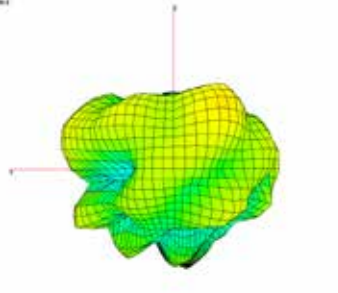
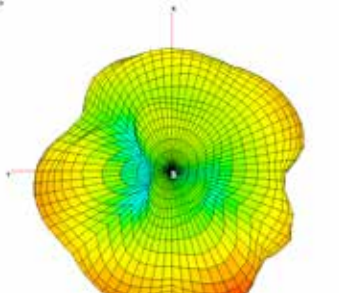
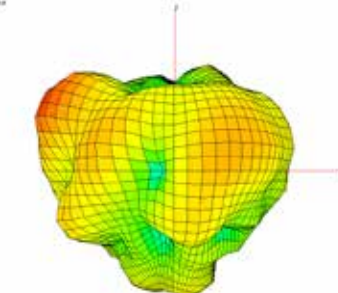
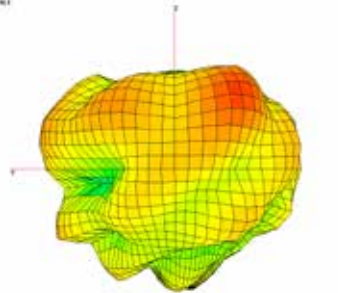
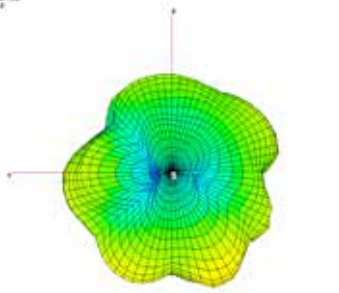
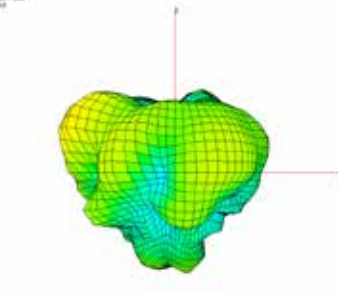
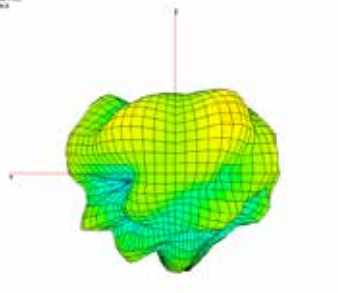
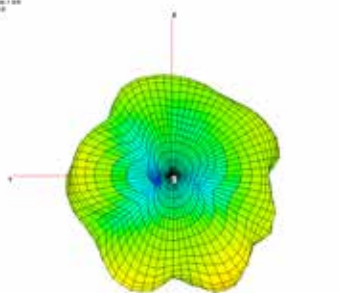
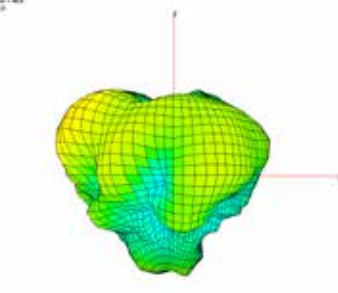
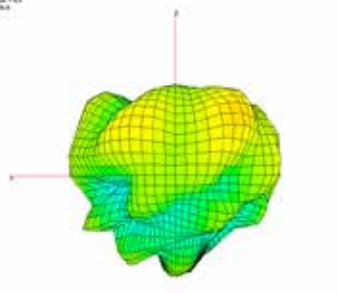
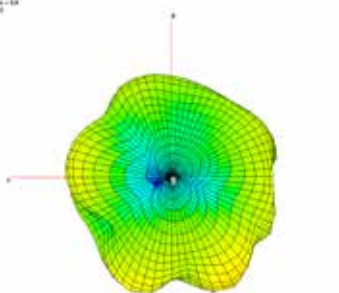
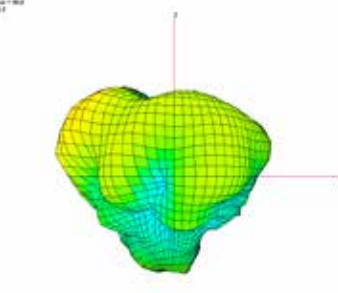
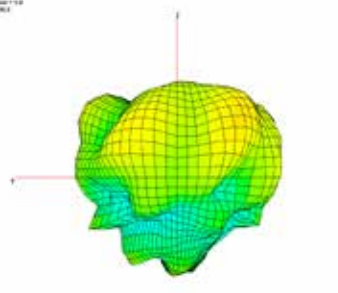
2370	<p>Amplitude: 0.02 Frequency: 1.00 Wavelength: 1.00</p> 	<p>Amplitude: 0.02 Frequency: 1.00 Wavelength: 1.00</p> 	<p>Amplitude: 0.02 Frequency: 1.00 Wavelength: 1.00</p> 
2401	<p>Amplitude: 0.02 Frequency: 1.00 Wavelength: 1.00</p> 	<p>Amplitude: 0.02 Frequency: 1.00 Wavelength: 1.00</p> 	<p>Amplitude: 0.02 Frequency: 1.00 Wavelength: 1.00</p> 
2449	<p>Amplitude: 0.02 Frequency: 1.00 Wavelength: 1.00</p> 	<p>Amplitude: 0.02 Frequency: 1.00 Wavelength: 1.00</p> 	<p>Amplitude: 0.02 Frequency: 1.00 Wavelength: 1.00</p> 
2497	<p>Amplitude: 0.02 Frequency: 1.00 Wavelength: 1.00</p> 	<p>Amplitude: 0.02 Frequency: 1.00 Wavelength: 1.00</p> 	<p>Amplitude: 0.02 Frequency: 1.00 Wavelength: 1.00</p> 
2545	<p>Amplitude: 0.02 Frequency: 1.00 Wavelength: 1.00</p> 	<p>Amplitude: 0.02 Frequency: 1.00 Wavelength: 1.00</p> 	<p>Amplitude: 0.02 Frequency: 1.00 Wavelength: 1.00</p> 

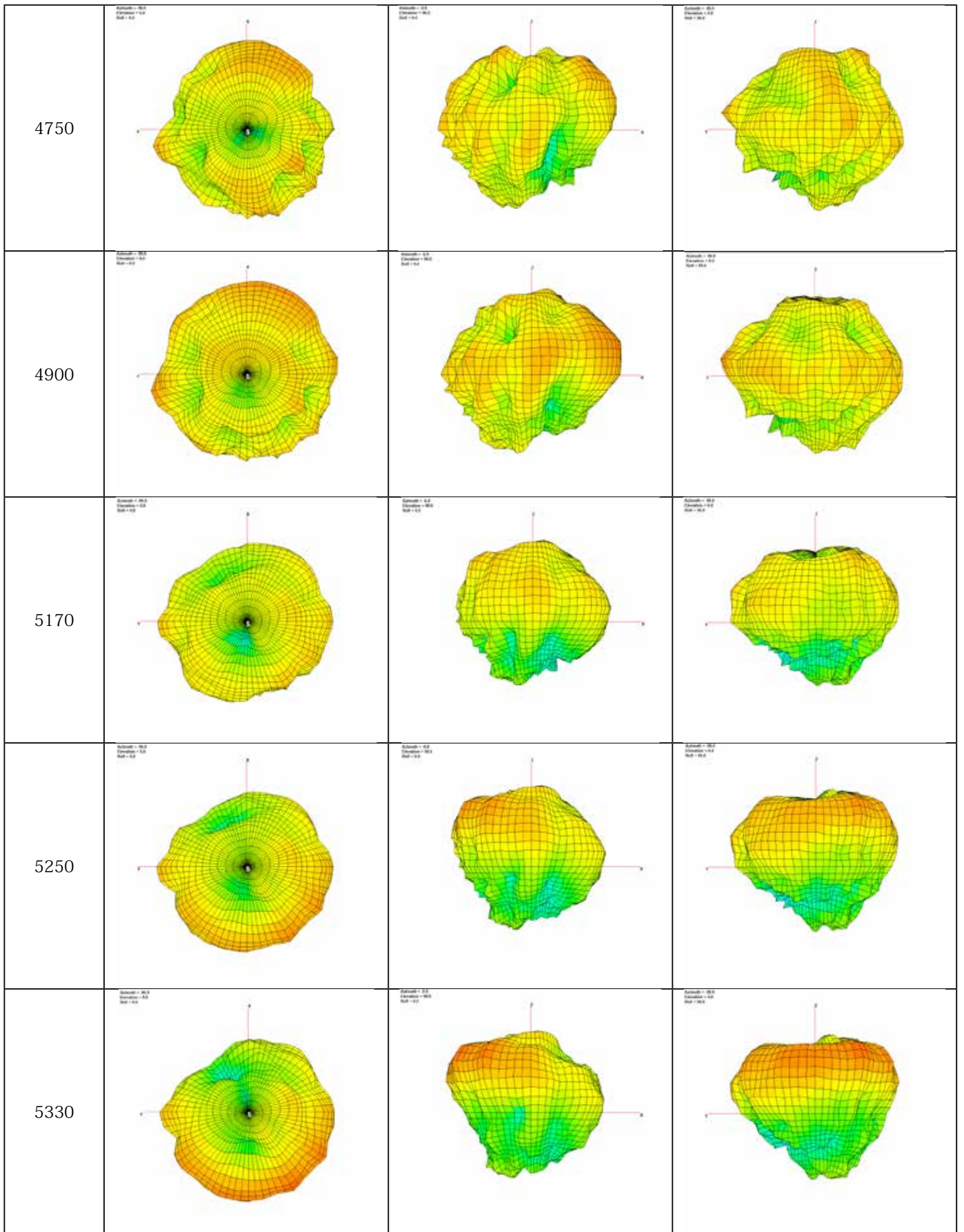

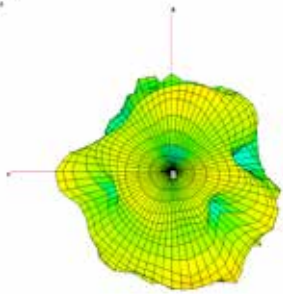
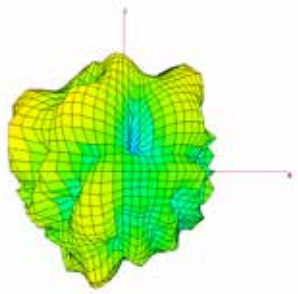
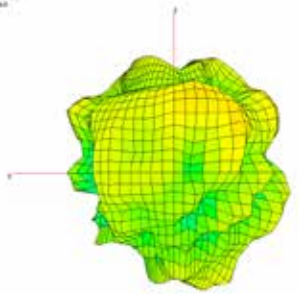
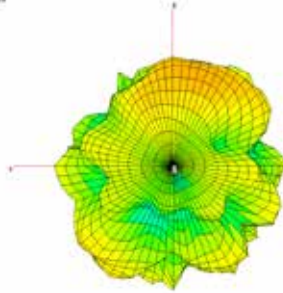
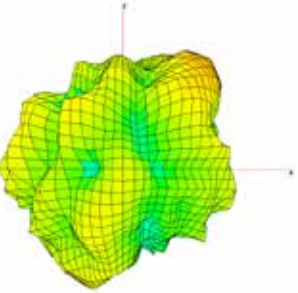
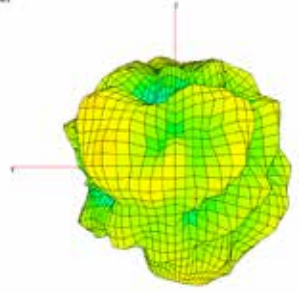
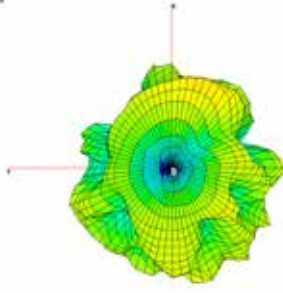
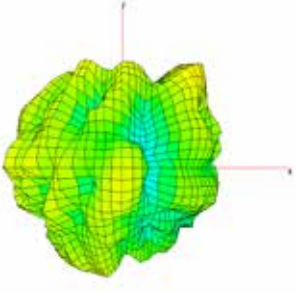
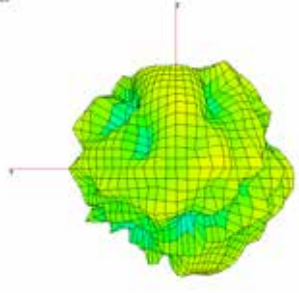
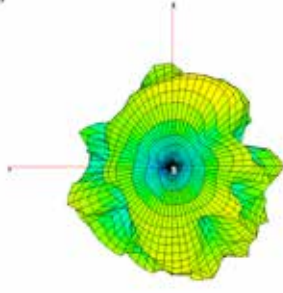
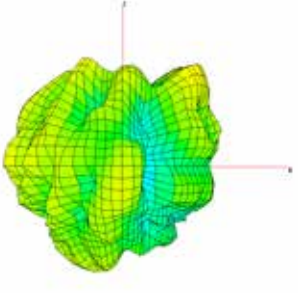
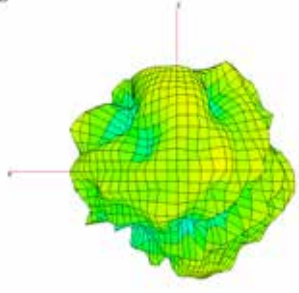
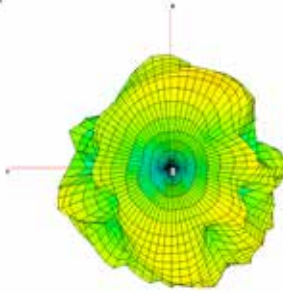
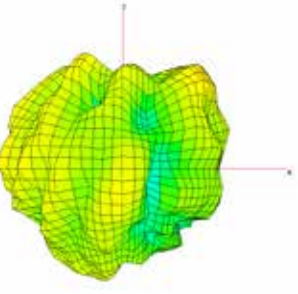
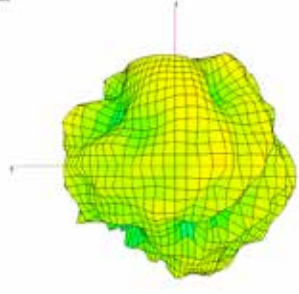
3850	 <p>Iteration = 30 Error = 1.0 Max = 1.0</p>	 <p>Iteration = 30 Error = 1.0 Max = 1.0</p>	 <p>Iteration = 30 Error = 1.0 Max = 1.0</p>
4100	 <p>Iteration = 30 Error = 1.0 Max = 1.0</p>	 <p>Iteration = 30 Error = 1.0 Max = 1.0</p>	 <p>Iteration = 30 Error = 1.0 Max = 1.0</p>
4500	 <p>Iteration = 30 Error = 1.0 Max = 1.0</p>	 <p>Iteration = 30 Error = 1.0 Max = 1.0</p>	 <p>Iteration = 30 Error = 1.0 Max = 1.0</p>
4550	 <p>Iteration = 30 Error = 1.0 Max = 1.0</p>	 <p>Iteration = 30 Error = 1.0 Max = 1.0</p>	 <p>Iteration = 30 Error = 1.0 Max = 1.0</p>
4600	 <p>Iteration = 30 Error = 1.0 Max = 1.0</p>	 <p>Iteration = 30 Error = 1.0 Max = 1.0</p>	 <p>Iteration = 30 Error = 1.0 Max = 1.0</p>

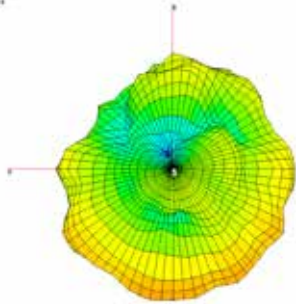
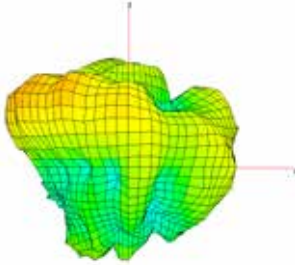
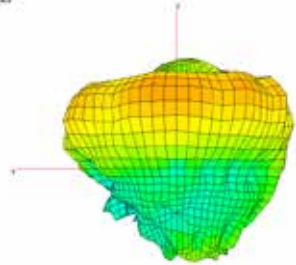
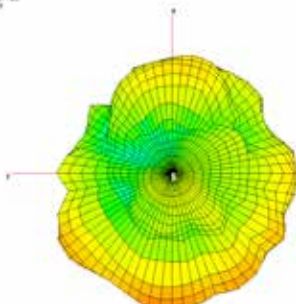
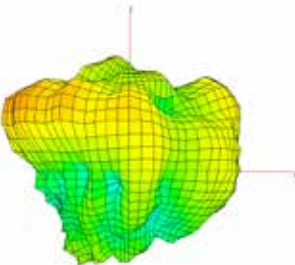
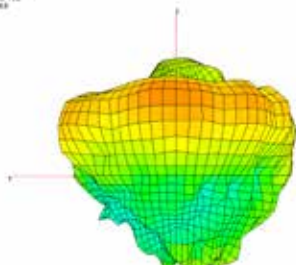
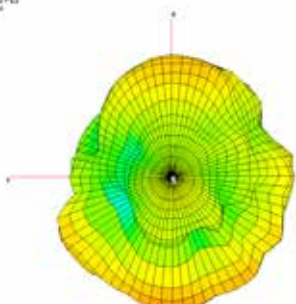
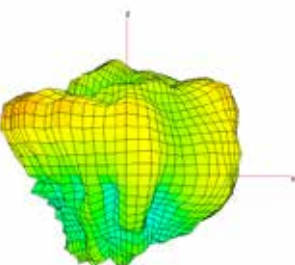
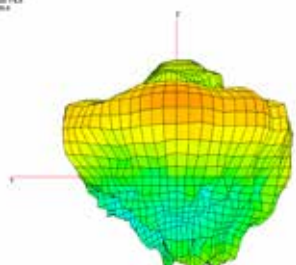
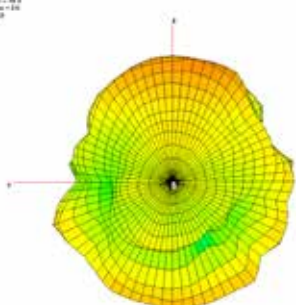
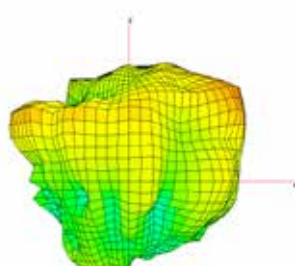
5490	<p>Amplitude: 0.2 Frequency: 1.0 Scale: 1.0</p> 	<p>Amplitude: 0.2 Frequency: 0.5 Scale: 1.0</p> 	<p>Amplitude: 0.2 Frequency: 0.5 Scale: 1.0</p> 
5610	<p>Amplitude: 0.2 Frequency: 1.0 Scale: 1.0</p> 	<p>Amplitude: 0.2 Frequency: 0.5 Scale: 1.0</p> 	<p>Amplitude: 0.2 Frequency: 0.5 Scale: 1.0</p> 
5730	<p>Amplitude: 0.2 Frequency: 1.0 Scale: 1.0</p> 	<p>Amplitude: 0.2 Frequency: 0.5 Scale: 1.0</p> 	<p>Amplitude: 0.2 Frequency: 0.5 Scale: 1.0</p> 
5945	<p>Amplitude: 0.2 Frequency: 1.0 Scale: 1.0</p> 	<p>Amplitude: 0.2 Frequency: 0.5 Scale: 1.0</p> 	<p>Amplitude: 0.2 Frequency: 0.5 Scale: 1.0</p> 